

USA

USA

Body 1

print 2x

A

C

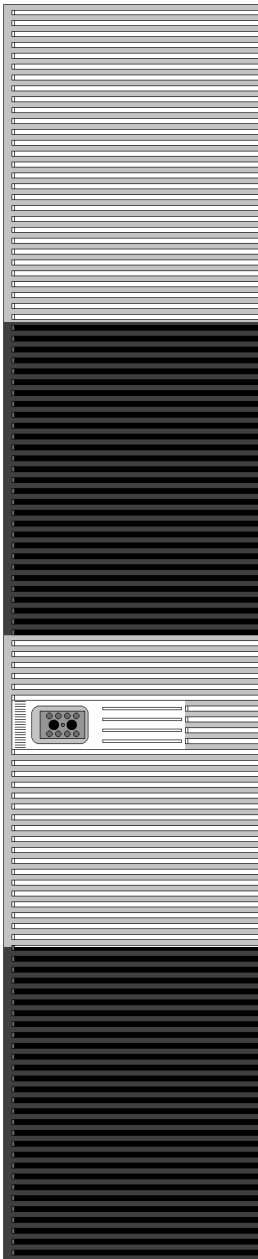

B

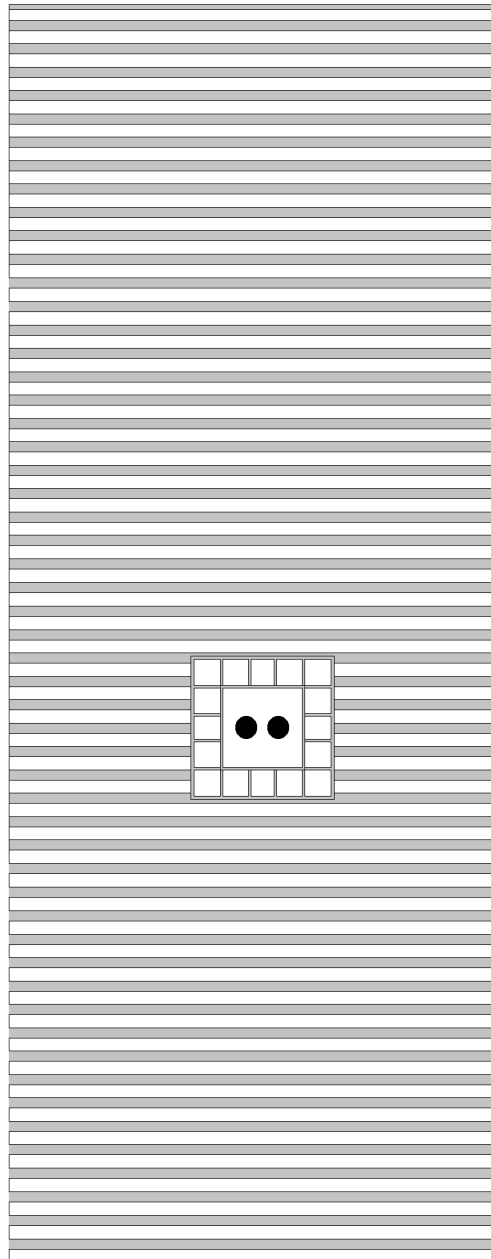

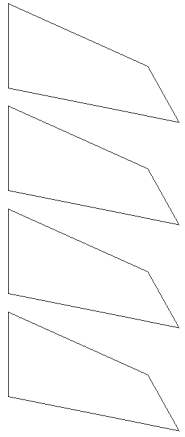

Glue to cardboard and then glue inside fin

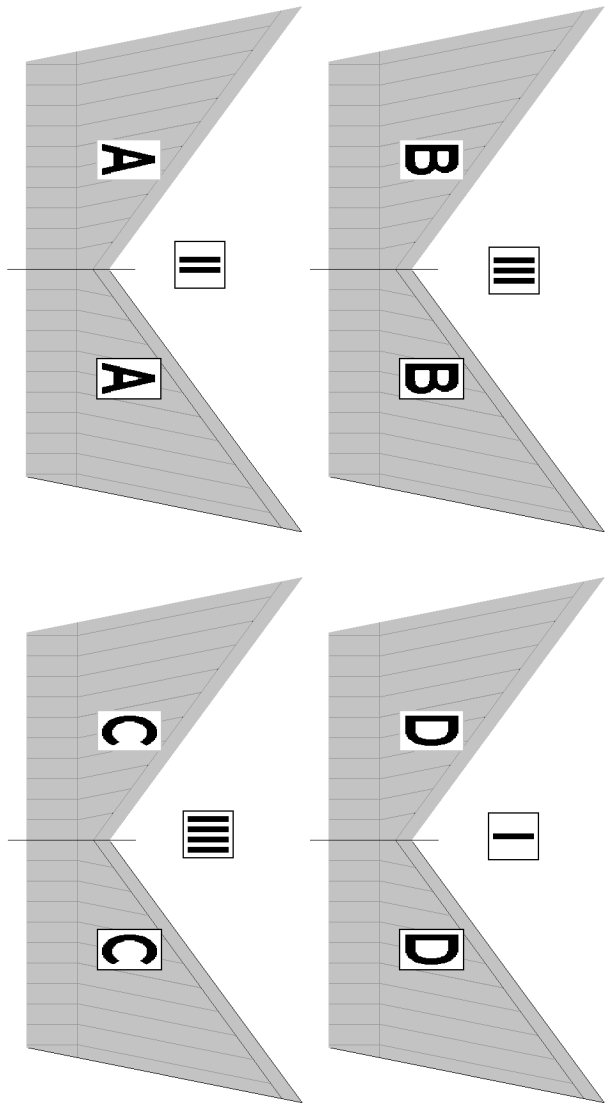

Engine fearling

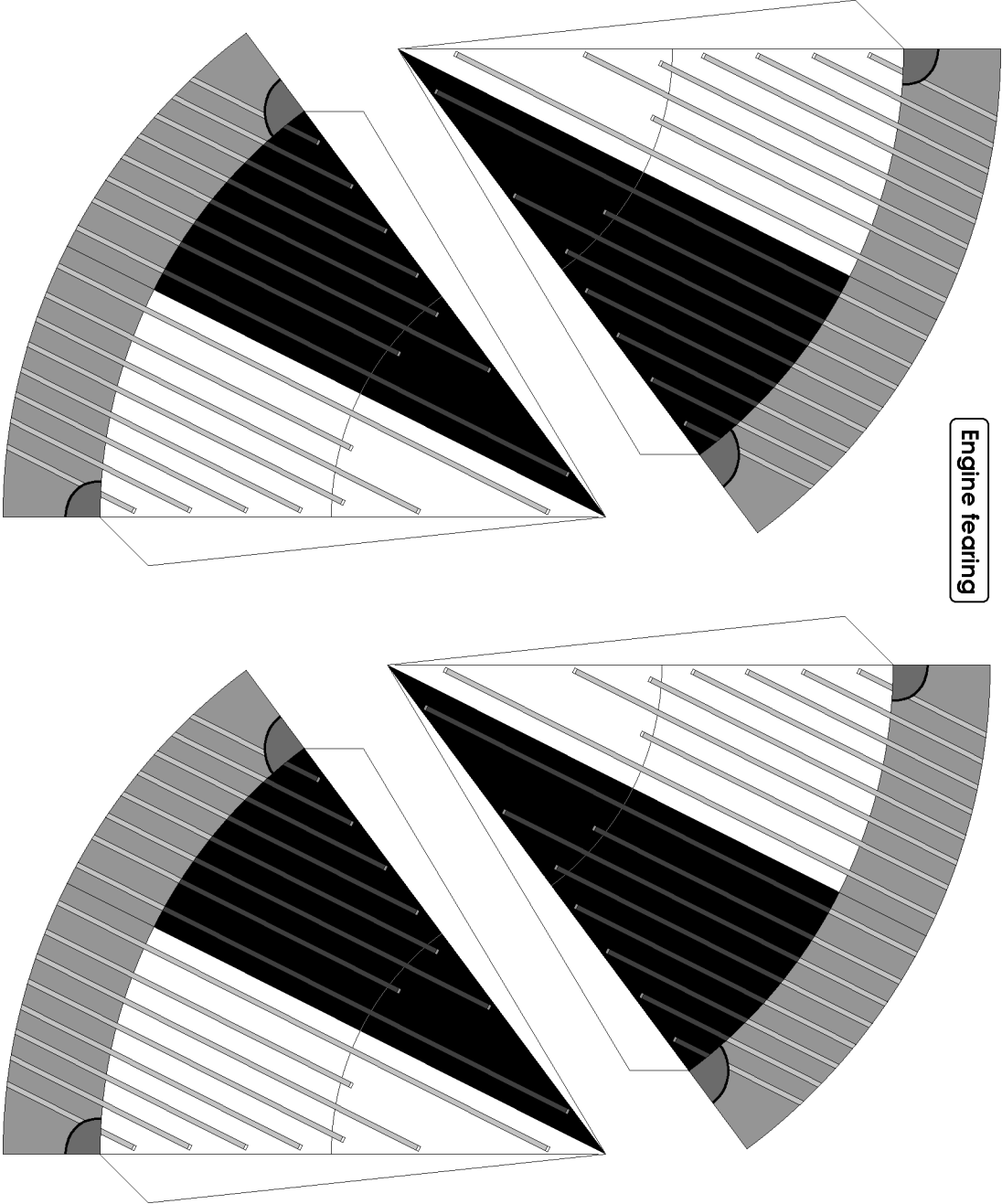

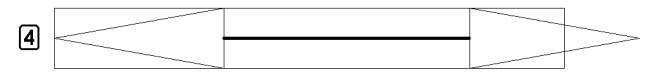
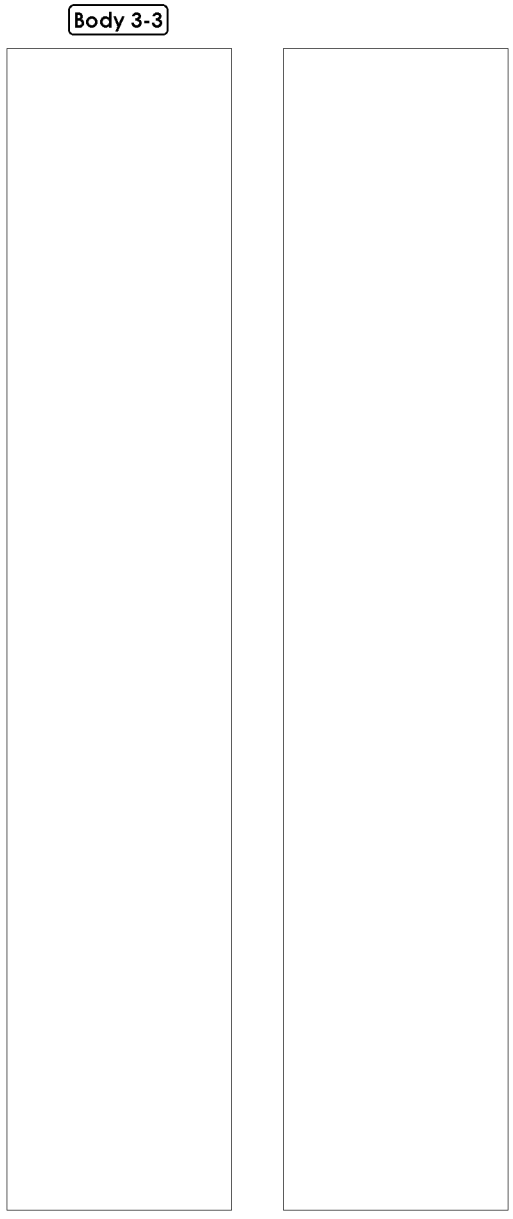
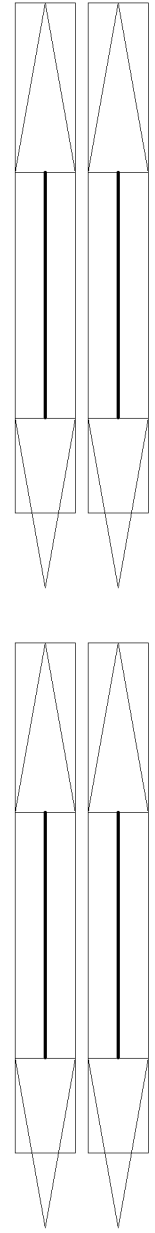
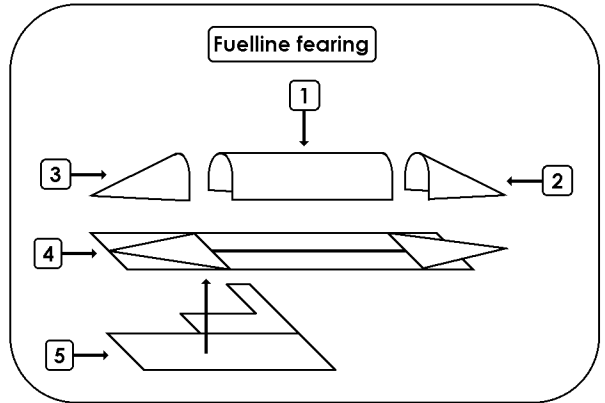
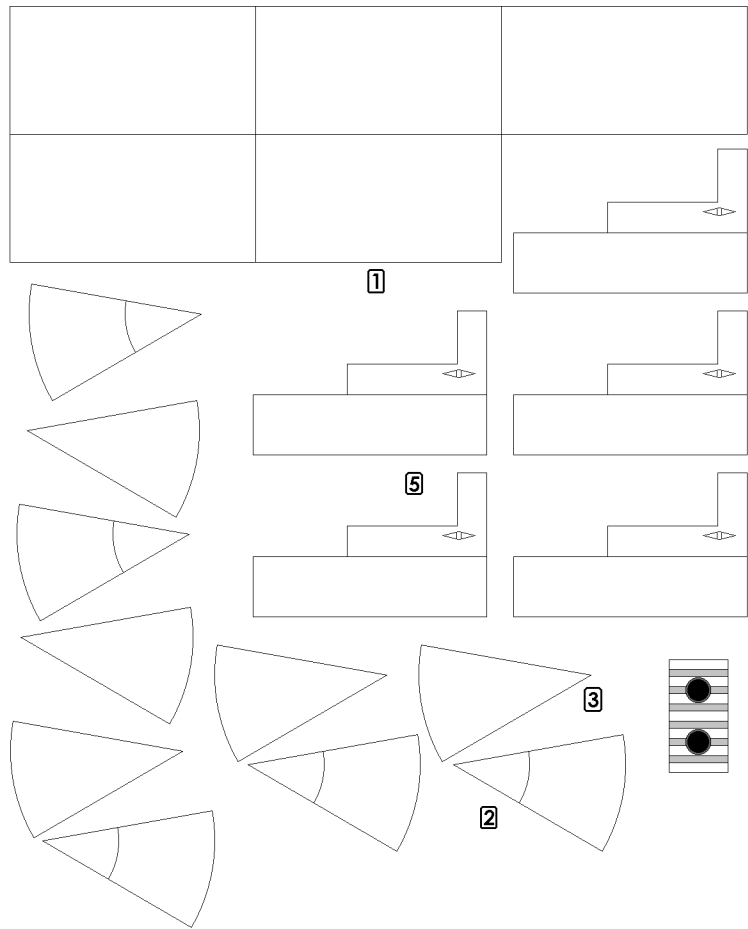
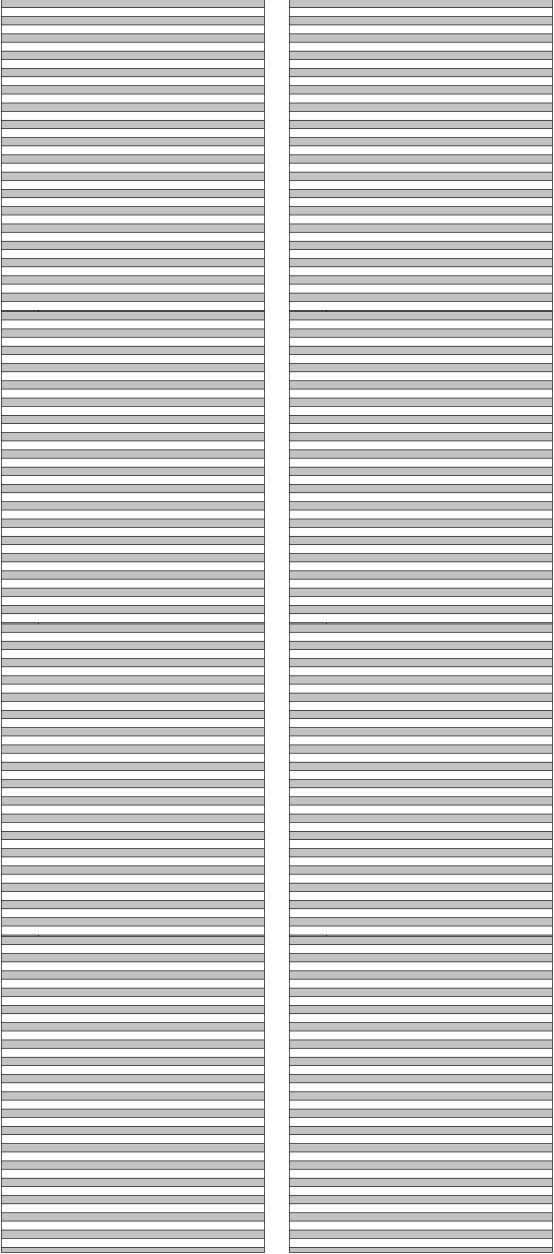

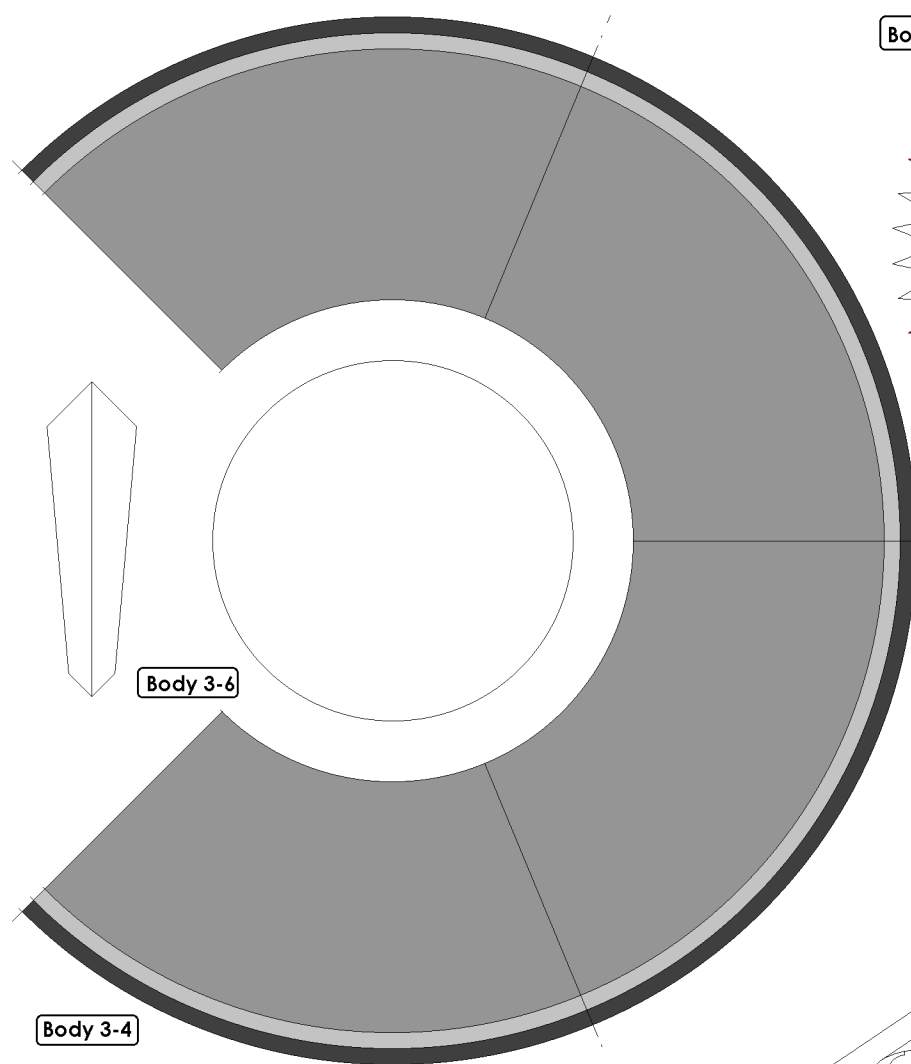

Body 3-5

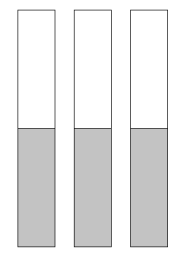
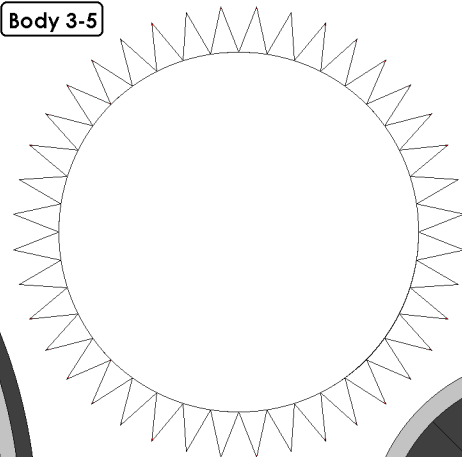

J2-3

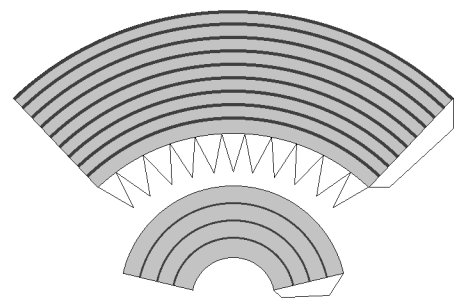
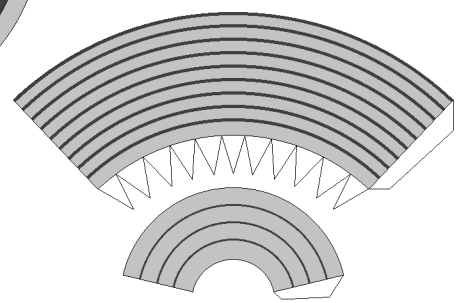
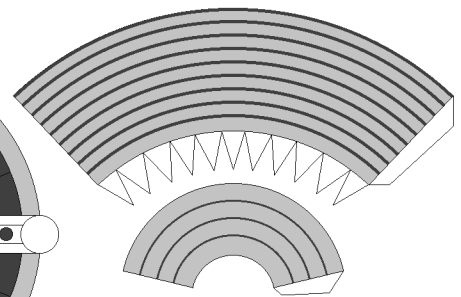
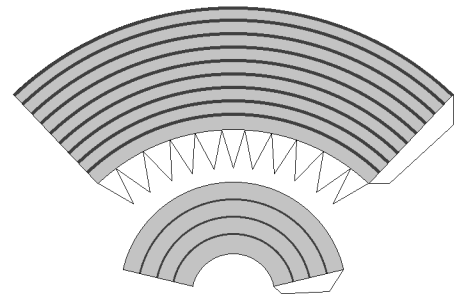

Body 3-6

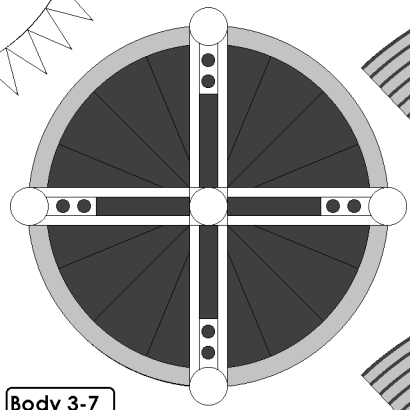
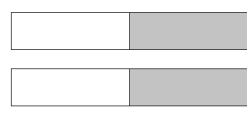

Body 3-7



Fuelline assembly



Vent assembly

Body 3-4

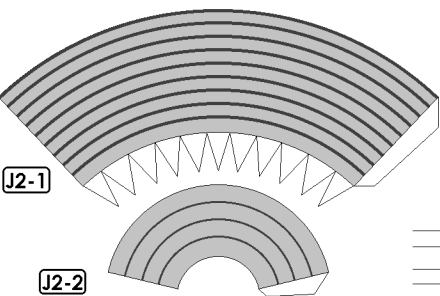

J2-1

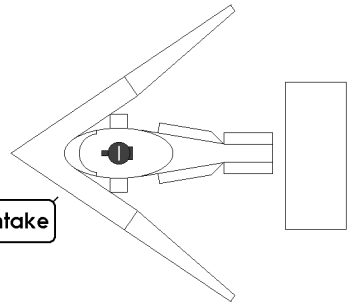

fuelintake

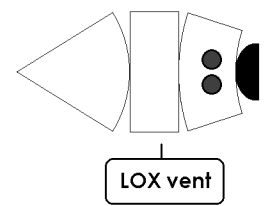

LOX vent

instrument duct

