

Apollo SM/CM

Take normal paper. Roll to a tight massive pipe and glue it into the top of cone. make it ± 4 mm longer and impregnate the paper with superglue. Cut the end into a sphere.

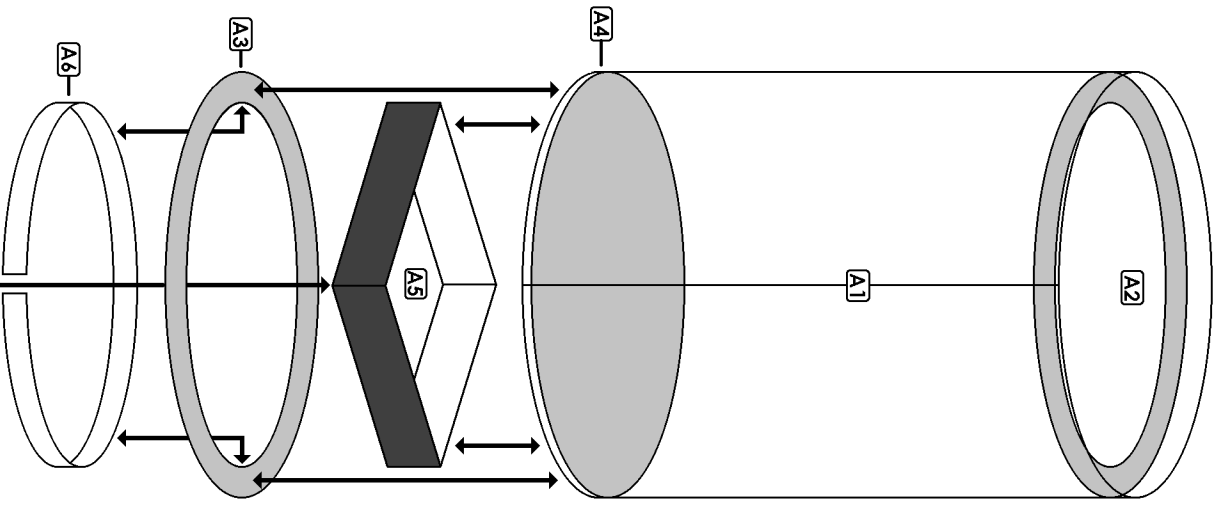

Paint the inside of the engine black

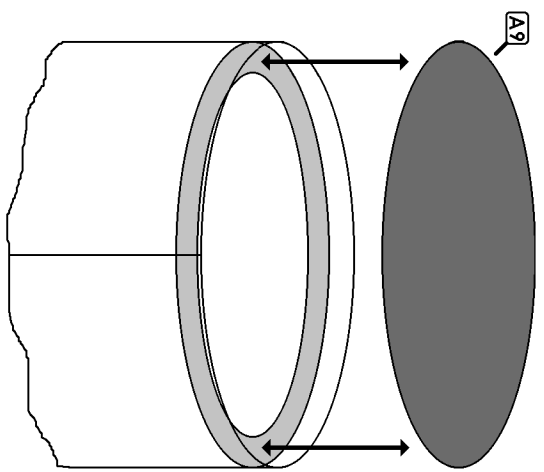
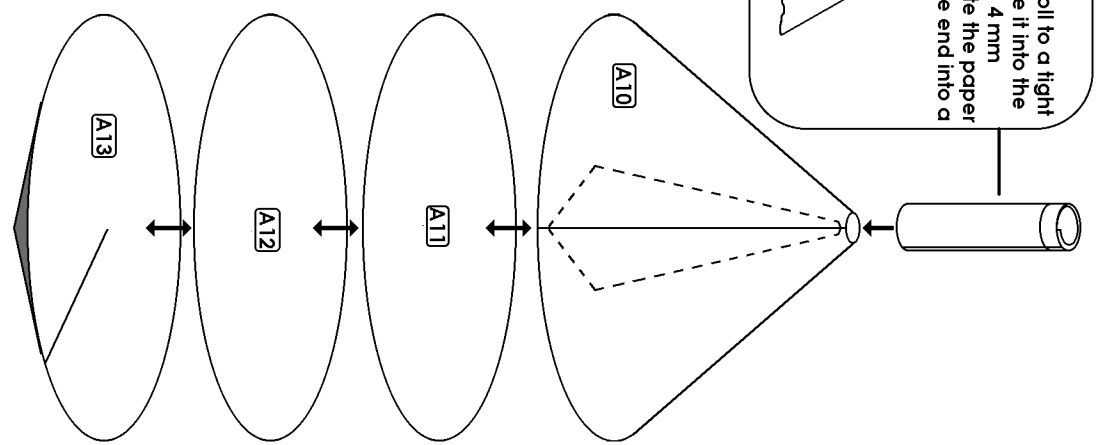
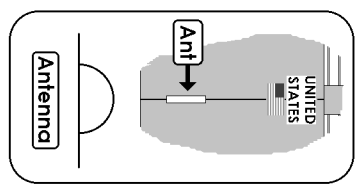
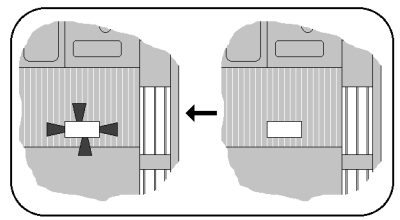
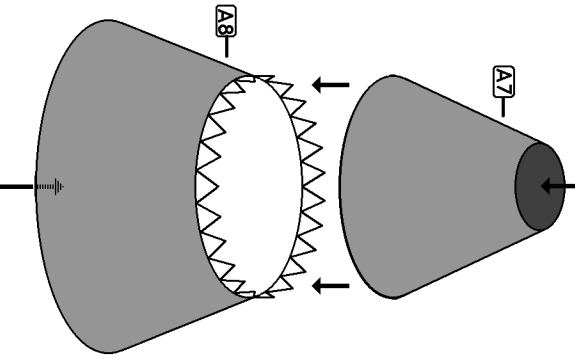

Apollo escape-tower

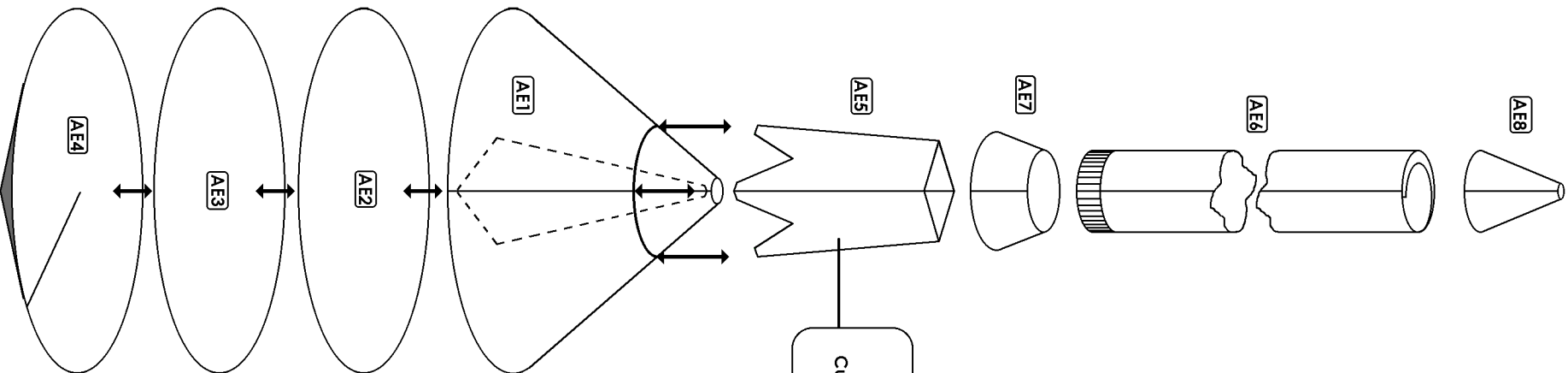

DIFFICULT!!
Cut out the latticework of the escape tower.....For a much better effect.
It can be done!

Take normal paper. Roll to a tight massive pipe and glue it into the top of cone. make it ± 4 mm longer and impregnate the paper with superglue. Cut the end into a sphere.

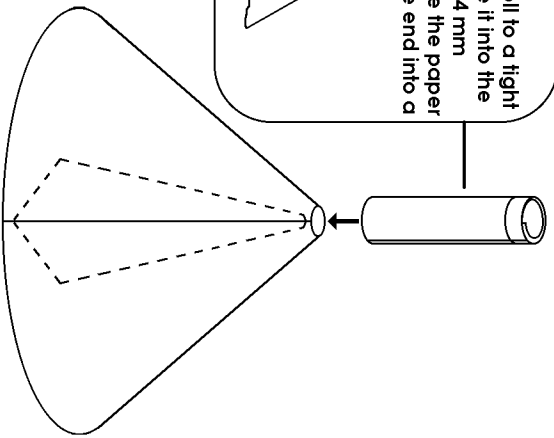

Apollo SM/CM

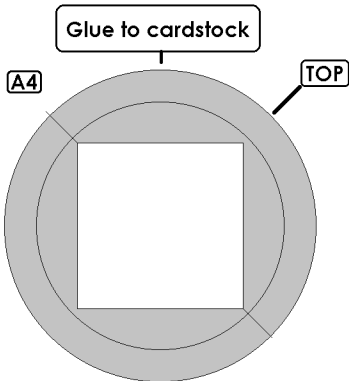
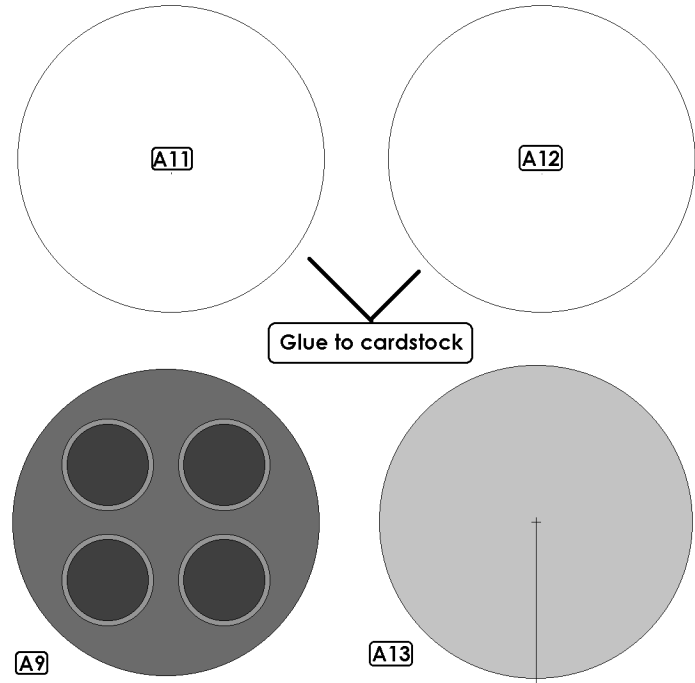
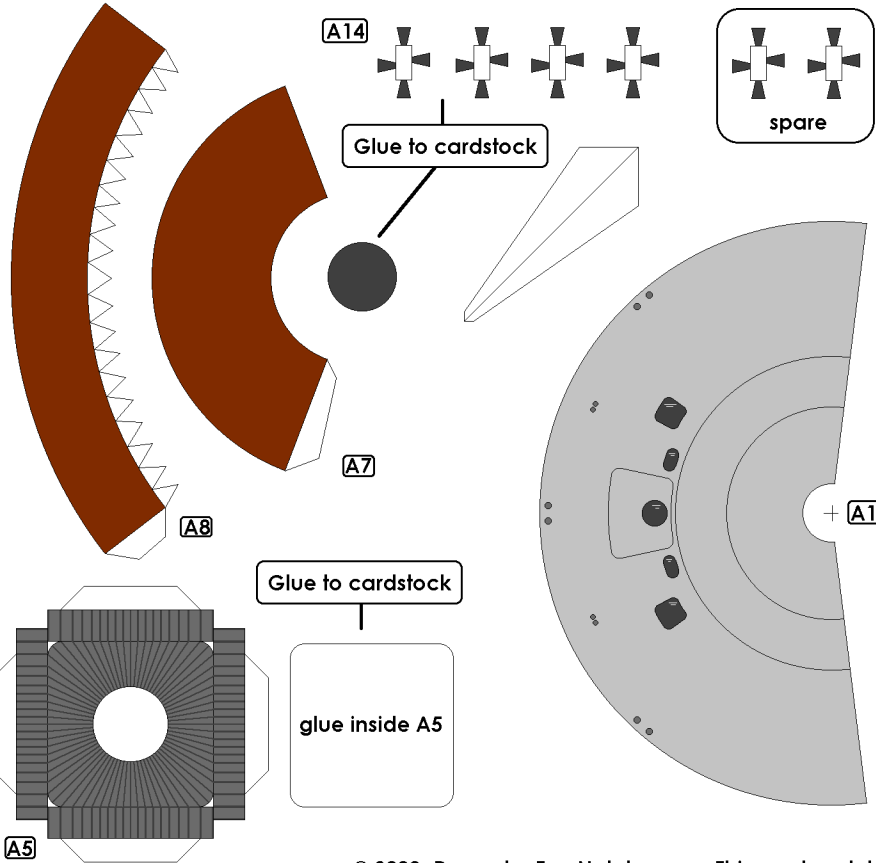
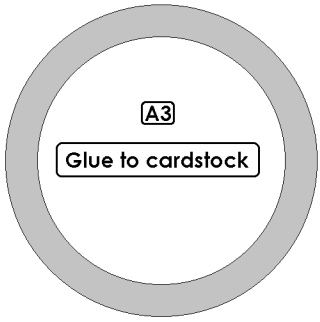
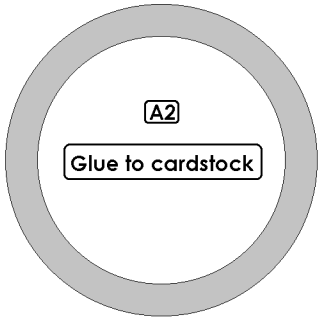
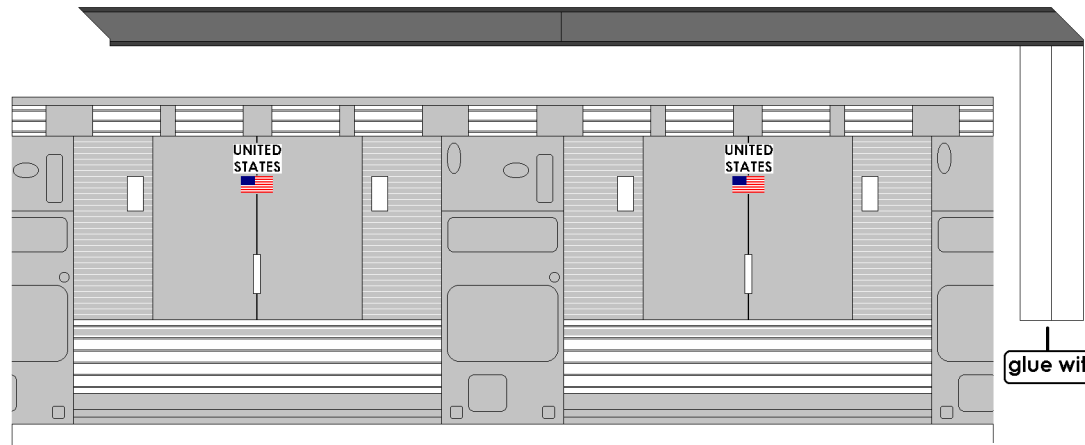

A6

Apollo escape tower

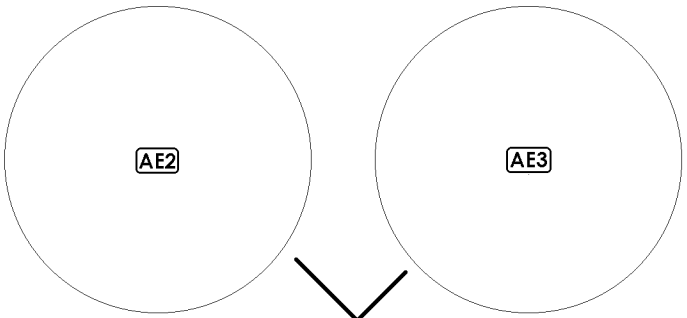

Glue to cardstock

