



# The Apollo Historical Series

## Apollo 14

31 Jan – 9 Feb 1971



**Apollo 14** was the eighth manned mission in the Apollo program and the third mission to land on the Moon, touching down on February 5, 1971.

### Crew

Alan B. Shepard, Jr - Commander

Stuart A. Roosa - Command Module Pilot

Edgar D. Mitchell - Lunar Module Pilot

After landing in the Fra Mauro formation - the destination for Apollo 13 - Shepard and Mitchell took two moon walks, adding new seismic studies to the by now familiar Apollo experiment package, and using a "lunar rickshaw" pull cart to carry their equipment. Roosa, meanwhile, took pictures from on board command module *Kitty Hawk* in lunar orbit.

The second moonwalk, or EVA, was intended to reach the rim of the 1,000 foot (300 m) wide Cone Crater. However, the two astronauts were not able to find the rim amid the rolling terrain of the crater's slopes. Later analysis, using the pictures that they took, determined that they had come within 65 feet of the crater's rim. Shepard and Mitchell deployed and activated various scientific instruments and experiments and collected almost 100 pounds (45 kg) of lunar samples for return to earth. Other Apollo 14 achievements included: first use of Mobile Equipment Transporter (MET); largest payload placed in lunar orbit; longest distance traversed on the lunar surface; largest payload returned from the lunar surface; longest lunar surface stay time (33 hours); longest lunar surface EVA (9 hours and 17 minutes); first use of shortened lunar orbit rendezvous techniques; first use of color TV with new vidicon tube on lunar surface; and first extensive orbital science period conducted during CSM solo operations.

On the way back to Earth, the crew conducted the first U.S. materials processing experiments in space. The Apollo 14 astronauts were the last lunar explorers to be quarantined on their return from the Moon.

Mission name	<i>Apollo 14</i>
Command Module	CM-110 Callsign <i>Kitty Hawk</i> mass 29,240 kg
Service Module	SM-110
Lunar Module	LM-8 Callsign <i>Antares</i> mass 15,264 kg
Crew size	3
Booster	Saturn V SA-509
Launch pad	LC 39A Kennedy Space Center Florida, USA
Launch date	January 31, 1971 21:03:02 UTC

Lunar EVA duration	First 04:47:50 Second 04:34:41 Total 09:22:31
Lunar surface time	1 d 09 h 30 m 29 s
Lunar sample mass	42.28 kg (93.21 lb)
Time in lunar orbit	2 d 18 h 35 m 39 s
Landing	February 9, 1971 21:05:00 UTC 27°1'S, 172°39'W
Mission duration	9 d 00 h 01 m 58 s

### Special Thanks To:

Save the LUT  
<http://savethelut.com>

Kip Teague, The Project Apollo Image Gallery  
[http://apolloarchive.com/apollo\\_gallery.html](http://apolloarchive.com/apollo_gallery.html)

Ton Noteboom

Wikipedia  
[http://en.wikipedia.org/wiki/Main\\_Page](http://en.wikipedia.org/wiki/Main_Page)

And the wonderful folks at the Yahoo LUT Forum

1. Print the Launcher Base, Tower Base, and Tower pages on cardstock. Print the Saturn V, the Tower Access Arms, and the sheet of Auxiliary parts to regular printer paper.

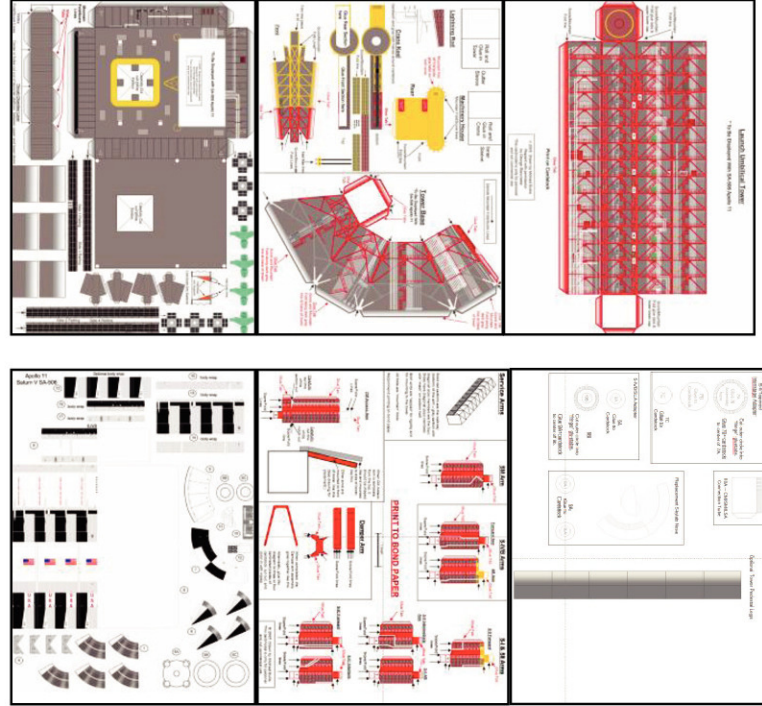

2. Score & cut out Thrust Liner



3. Fold glue tabs out, printed side in, and glue as shown.

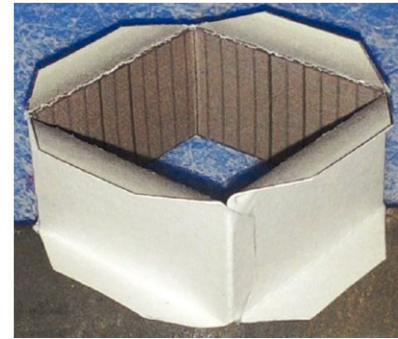

4. Score, cut out and fold Launcher Base. Carefully cut out

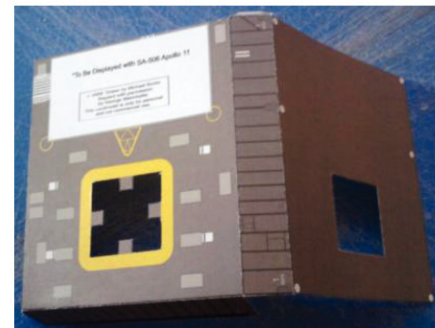

5. Glue thrust liner to inside of Launcher Base, carefully aligning with the hole cut in the previous step.



6. Glue shut the Launcher Base

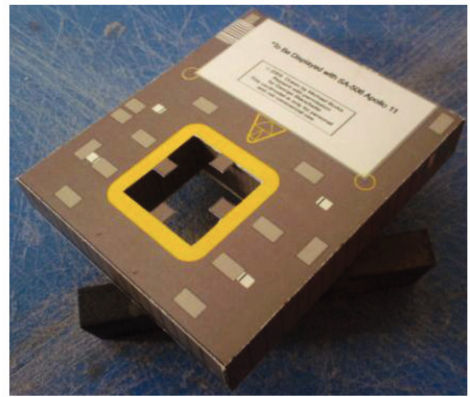

7. Score, cut out and glue the Hold Down Arm Supports

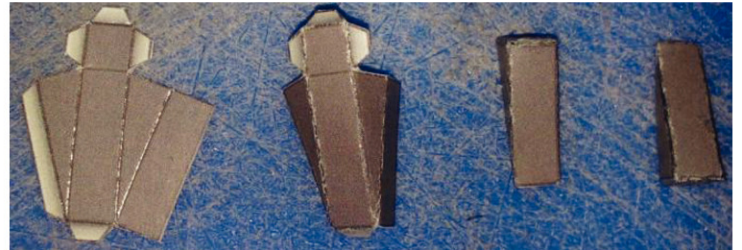

8. Glue the Hold Down Arm Supports on the inside of the Thrust Chamber, aligned under the squares on the top of the Launcher Base, as shown.

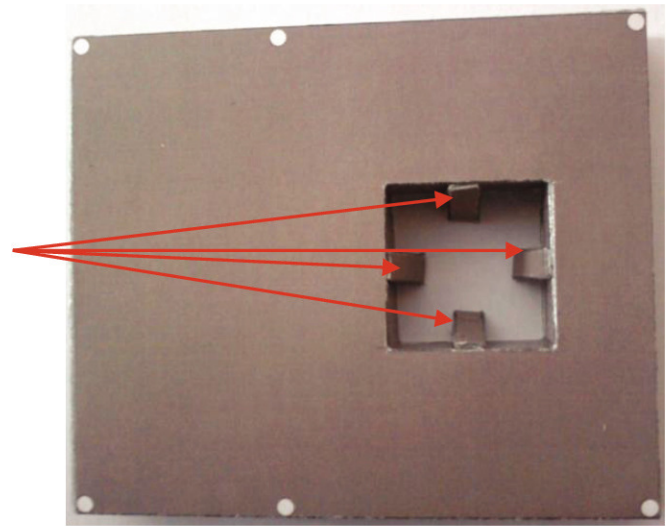

9. If you wish to use the Launcher Pedestals, cut out and form the Pedestal Platforms. Drill out the holes indicated. Roll and form the pedestal legs. If you find it easier to roll the tubes with regular printer paper, use the legs on the Auxiliary Parts sheet instead of the cardstock parts on the Launcher Base sheet. Glue the platforms  $\frac{1}{4}$  of the way up the legs, as shown.



10. If you choose to use the Launcher Base Pedestals, carefully drill out the holes indicated on the bottom of the Base, and insert the pedestals in the base.

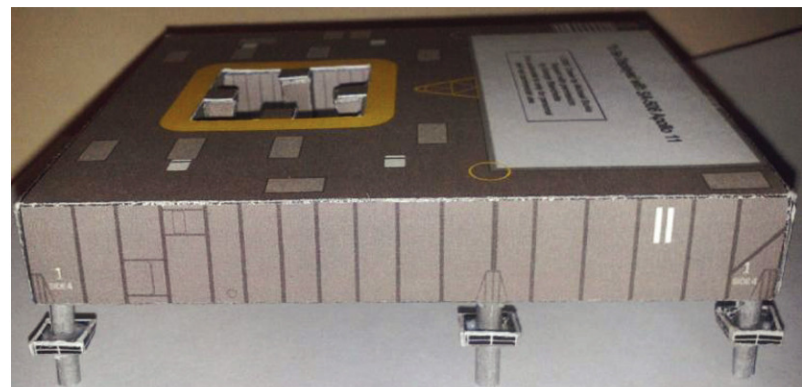

11. Score, cut out, fold, and glue Hold Down Arms. The parts are very small, and the score lines may be difficult to see. Refer to the diagram for the location of the score lines (in red) & glue tabs. Assemble as shown.

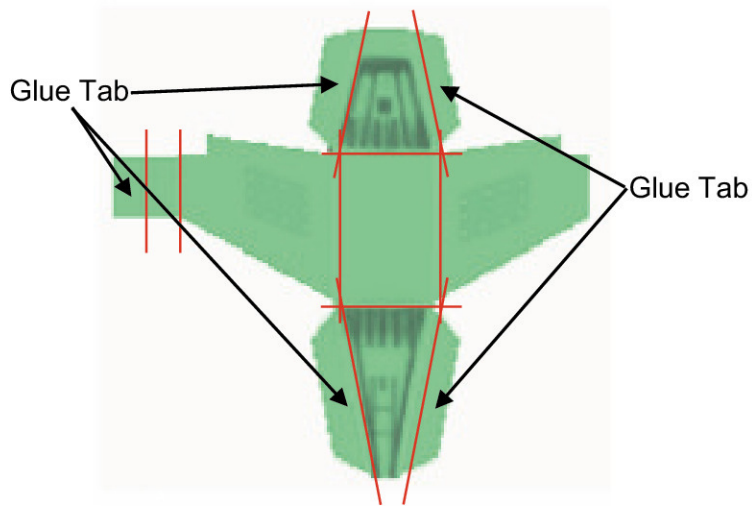

12. Cut out part 5A from Saturn V page & glue to cardstock. Use 5A to align and center the Hold Down Arms on the Launcher Base. Make sure to save Part 5A for Step 50.

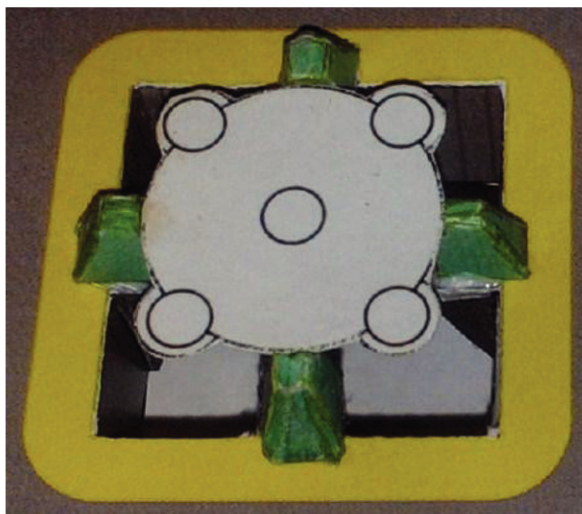

13. Score, cut out, fold, and assemble Tower Base. When dry, glue in place on Launcher Base.

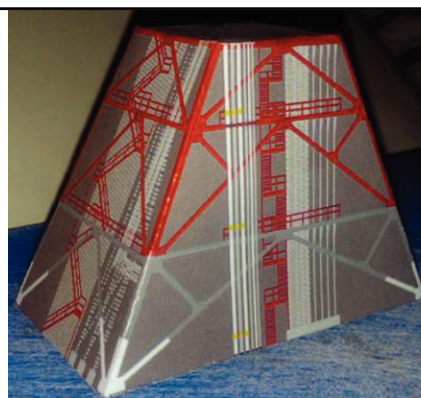

14. Cut out the Outer Sleeve, as shown in the photo. "Fringe" cut the remaining part as shown to make glue tabs.

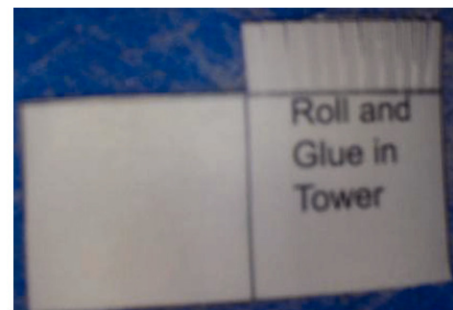

15. Roll sleeve into a tube, and fold "fringe" out.



16. Score, cut out, and fold Tower. Carefully cut out circle in top of Tower, as indicated. (And be more careful using the red marker to color the edge of the hole than I was...)

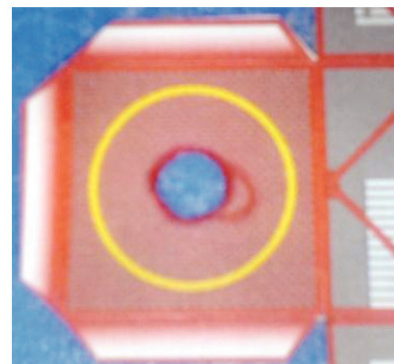

17. Glue Outer Sleeve to inside of top of tower, carefully aligning with hole cut in Step 16.

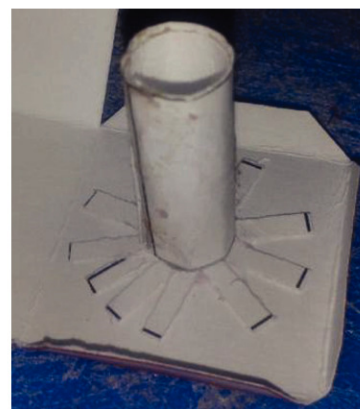

18. Close & glue up the rest of the tower.



19. Cut out and roll Inner Sleeve. Dry fit in hole/Outer Sleeve as shown in photo. Fit should be snug, but able to rotate freely. When sized properly, glue tube to final shape. Save Inner Sleeve for Step 26.



20. Score, cut out, fold, & glue together Launcher Base Rails. Glue in place as indicated. The black “rail” portion should extend above the platform, the gray portion should be even with the platform.

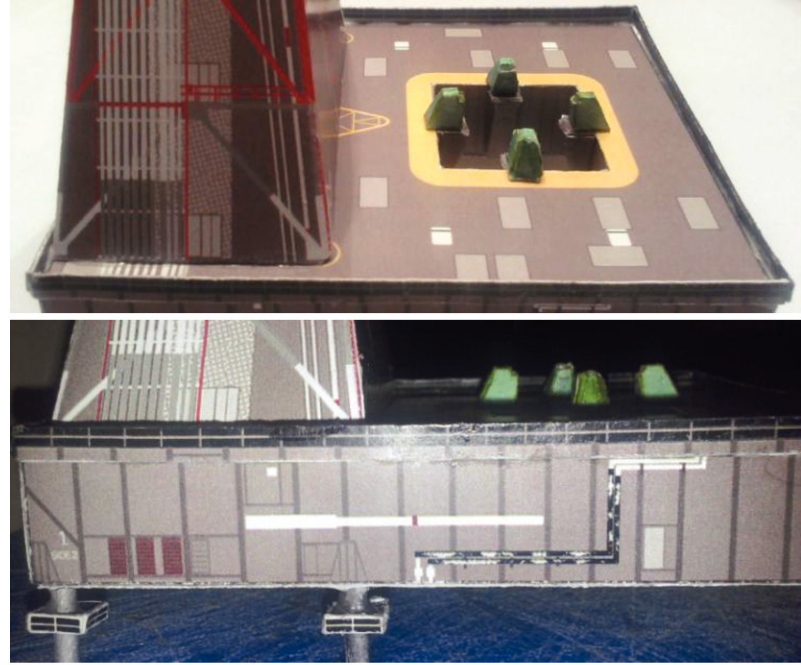

21. Score, cut out, & fold Crane Machinery House. Cut out area outside ends of Machinery House into “fringe” glue tabs, as shown.



22. Glue up remainder of Machinery House. Recommend using clay, a screw, etc. in the back of the part to act as a counterweight for the crane boom before gluing shut.



23. Cut out the two halves of the Crane Keel. Glue together, with the printed sides out

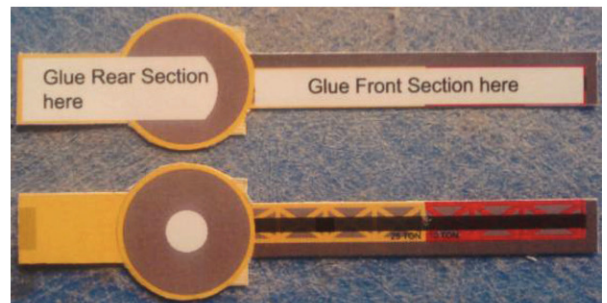

24. Glue the Machinery House to the Crane Keel in the location indicated



25. Score, cut out, fold, & glue together the Crane structure. As indicated on the part sheet, the aft end of the part should be trimmed carefully to fit. Glue in place on Crane Keel. Notice that the structure is offset, allowing for a "walkway" as indicated in the photo.

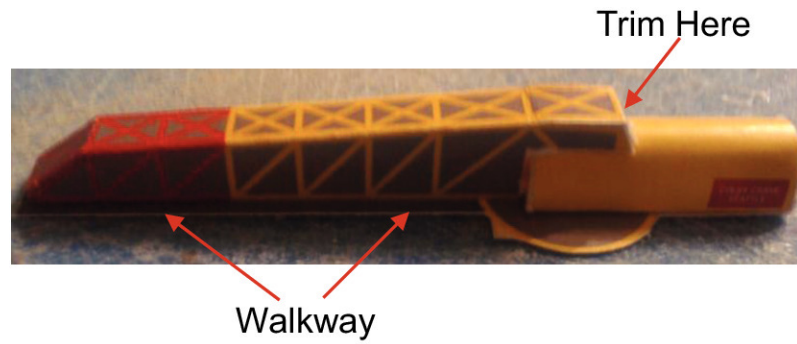

26. Score, cut out, fold, & glue together the Crane railing. It will need to be trimmed to fit. Glue to Crane, as shown

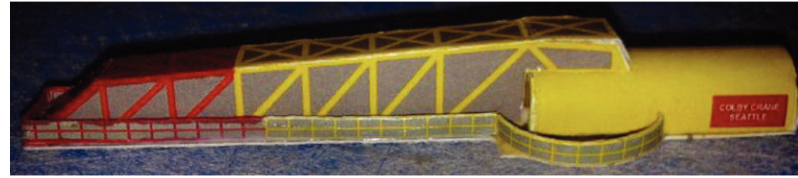

27. Score, cut out, fold, & glue together the Lightning Rod. Recommend cutting a small piece of toothpick, inserting half of it in the end of the Rod, drilling a small hole in the top of the Crane, and gluing together as shown.

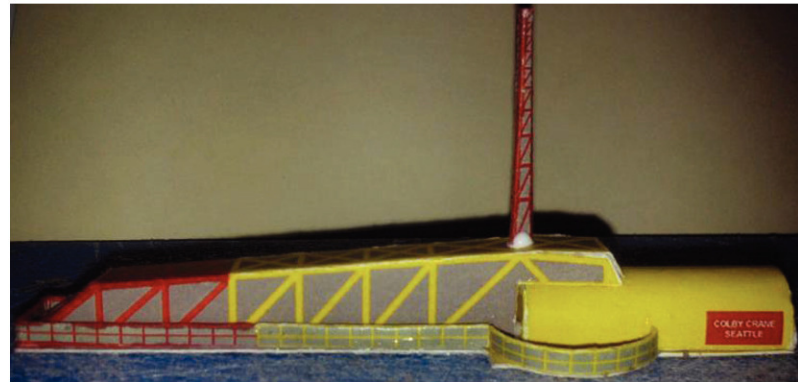

28. Carefully cut out circle in bottom of Crane Keel, also cutting thru bottom of Crane Structure. Glue Inner Sleeve from Step 17 into hole. A Crane Hook and length of cable are supplied. Score, cut, fold & glue together. Cut to desired length of cable and glue to desired location along underside of Crane Keel.

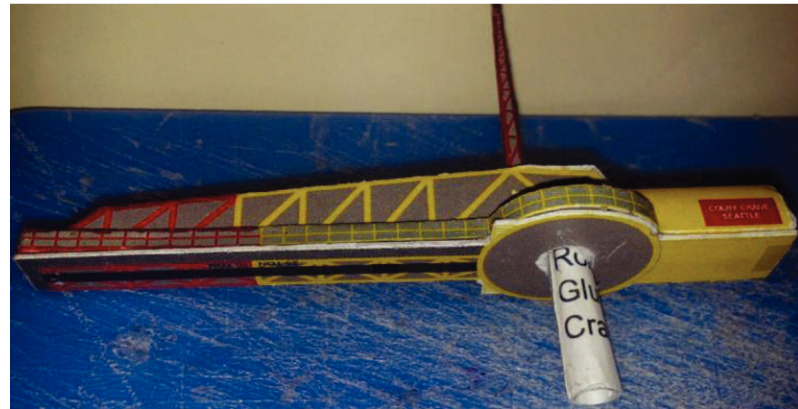

29. Glue Tower to Tower Base, as indicated. Carefully align "plumbing" in order to get proper orientation. When dry, insert Crane Inner Sleeve in Outer Sleeve in top of Tower, but do not glue in place.



30. Cut out Part 5, S-IC/S-II sheet. Note that there is an area to the right of the printed portion that is an underwrap area.

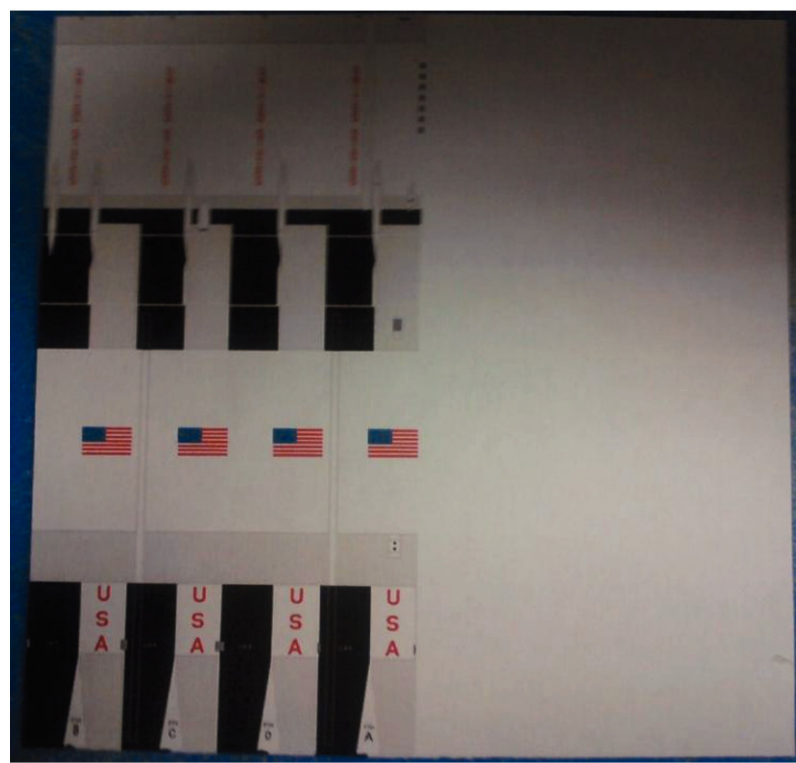

31. Roll and glue S-IC/S-II.

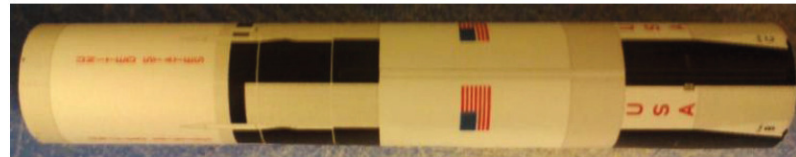

32. Glue Parts 5b and 5C to cardstock. When dry, cut out, and cut out center sections, forming rings



33. Glue Parts 5b and 5C inside both ends of Part 5, flush with the ends of the tube.



34. Cut out Parts 7A, 7B, and 7C from the Auxiliary part sheet. Cut outer section of Part 7A into "fringe" glue tabs. Glue 7B and 7C to cardstock and cut to shape. When dry, glue 7B/cardstock assembly to center of 7A.

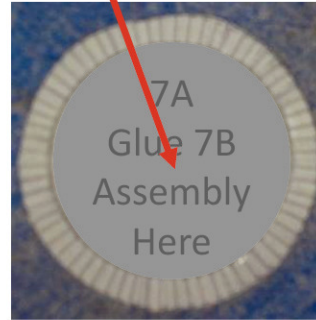
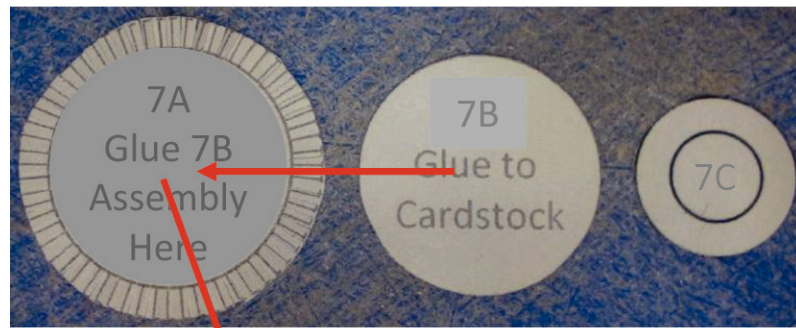

35. Cut out Part 7 and roll into a truncated cone. Glue part 7C into 7, flush with the end of 7. Bend the fringe glue tabs up, away from Part 7A.



36. Glue 7A/7B assembly in the open end of 7/7C assembly as shown.

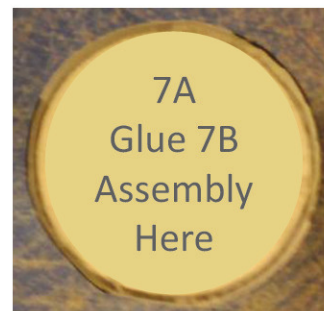

37. If you wish, glue on the body wraps.



38. Glue Part 7 assembly to end of Part 5 assembly.

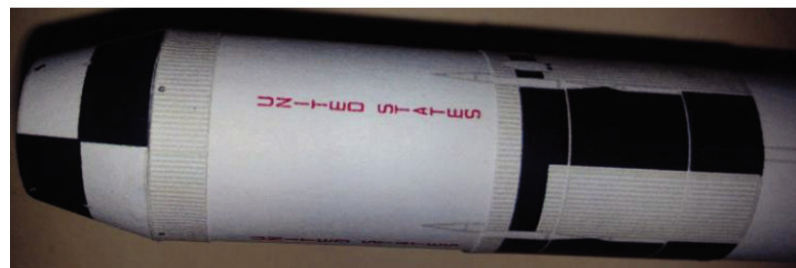

39. Glue part 9A from Auxiliary Part Sheet to cardstock. When dry, cut to shape. Cut out part 9B, and cut outside to make “fringe” gluetabs, like in Step 34. When dry, glue 9A to center of 9B, like was done in Step 34.

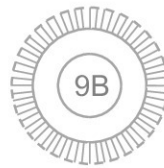

40. Cut out Part 9, Service Module/Lunar Module Adapter, and roll into truncated cone. As was done in Step 35, fold part 9B glue tabs away from 9A/cardstock assembly, then glue into bottom end of SLA, flush with bottom of part.



41. Cut out Part 8, S-IVB, and roll into tube, as shown.



42. Cut out Parts 8B & 8C, and glue to cardstock. When dry, cut to final shape and remove center section, as shown.

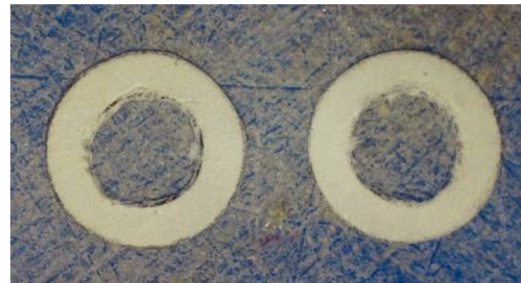

43. Glue Parts 8B and 8C/cardstock assemblies to ends of Part 8, flush with ends of tube.



44. If you wish, glue outer wraps to Part 8 assembly.



45. Glue SLA assembly to S-IVB Assembly.  
Note alignment of SLA panel to S-IVB detail.

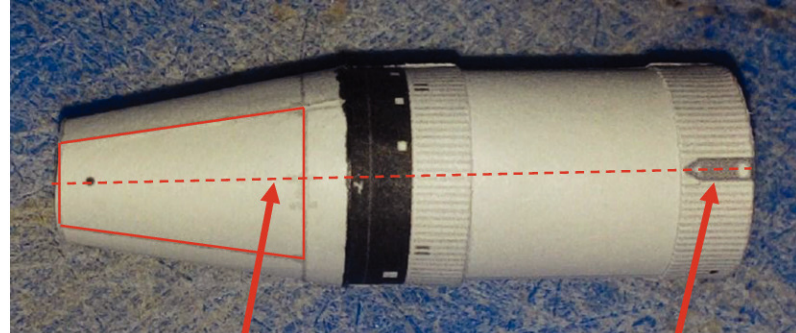

Centerline of SLA Panel

S-IVB Detail

46. Glue S-IVB assembly to rest of rocket. Note alignment of S-IVB detail to S-II/S-IVB Interstage. Note locations of S-IVB "Conduits"

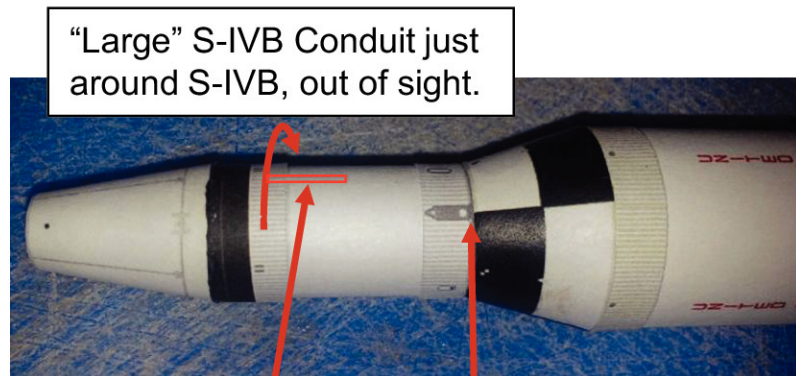

"Small" S-IVB Conduit

Note alignment

47. Cut out Service Module, roll, and glue into a tube. From Auxiliary Part Sheet, cut out Part 10A. Cut indicated area into "fringe" glue tabs. Roll 10A into a tube, and fit inside SM. Size the SM/SLA connector such that it fits snugly inside the SM. Glue connector inside SM with "fringe" at end of CM side of SM, as shown in photo.

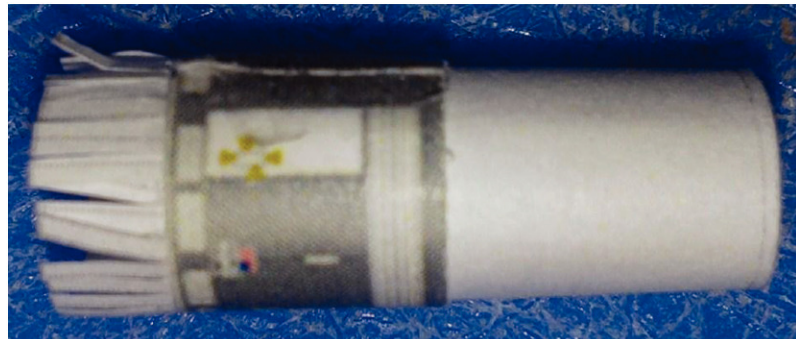

48. Cut out Apollo Boost Protective Cover and glue into cone.



49. Fold "fringe" glue tabs of SM/SLA adapter down, and glue Boost Protective Cover to SM. Note alignment of BPA hatch and RCS quad.



Hatch in line with RCS quad.

50. Glue BPA/SM to SLA. Note alignment of RCS quads relative to SLA panels.



RCS Quad aligned with center of SLA Panel

BPA Hatch is on OPPOSITE side of vehicle

51. Cut out Launch Escape System tower. Roll into a tube, and "fringe" the top end as shown.



52. Put a drop of glue in the "fringe petals", then pinch closed to form a point.



53. Glue LES tower to BPC.

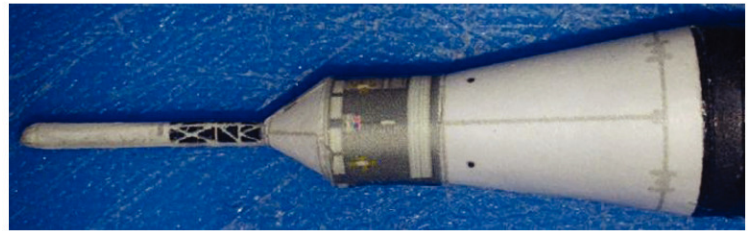

54. Glue Part 5A from Step 12 into place on the base of the vehicle. Note the letters near the base – these indicate the proper location of the lettered fins.

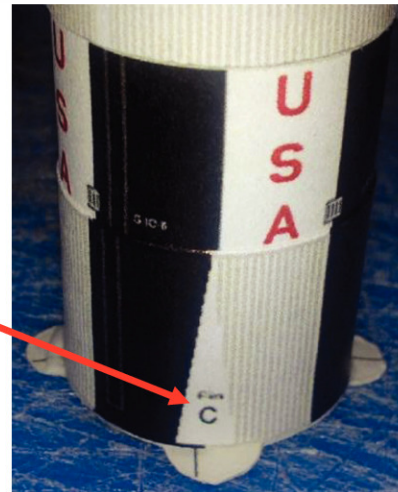

55. Score, cut out, & fold F-1 engine fairings and glue into place.

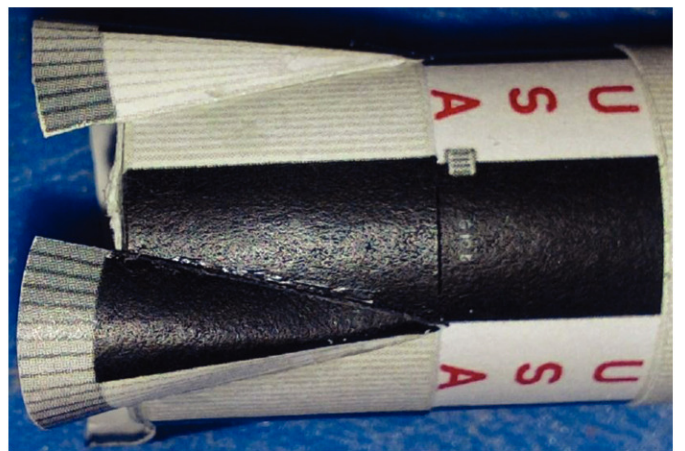

56. Cut out and form engines, then glue into place

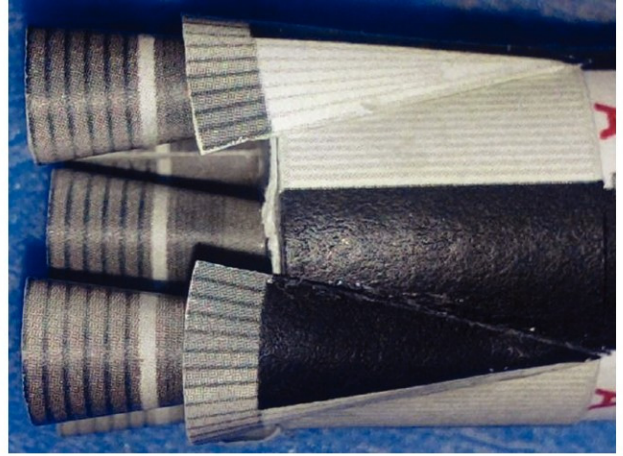

57. Score, cut out and fold fins in a continuous sheet. Sandwich and glue a piece of cardstock inside the folded fins. When dry, cut out the individual fins.

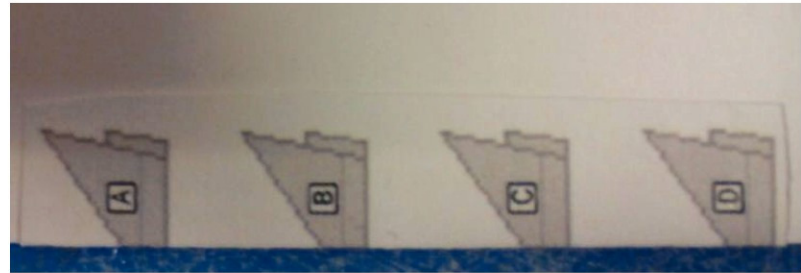

58. Remembering the location of the letters on the rocket base (as mentioned in Step 54), glue the corresponding fins to the engine fairings.



59. From the Auxiliary Parts Sheet, score, fold, and cut out Tail Service Mast towers.

Cut out 1 group of three Tail Service Mast Arms. Laminate 6 scrap pieces of cardstock approximately the size of the group of three arms. Glue the arms to the stack of cardstock. When this assembly is dry, with a sharp knife and a straightedge, carefully cut out the arms, being careful to cut straight through the assembly. Glue the other side of the arm to the assembly

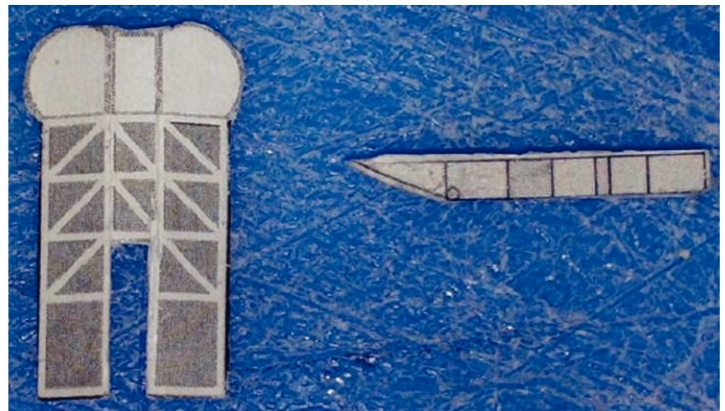

60. Fold a tower into an "open box" Glue an arm into the tower, as shown.

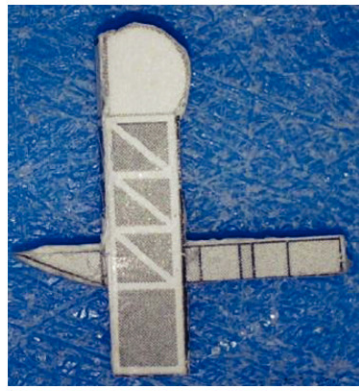

61. Glue Tail Service Masts into locations shown in diagram and photo.

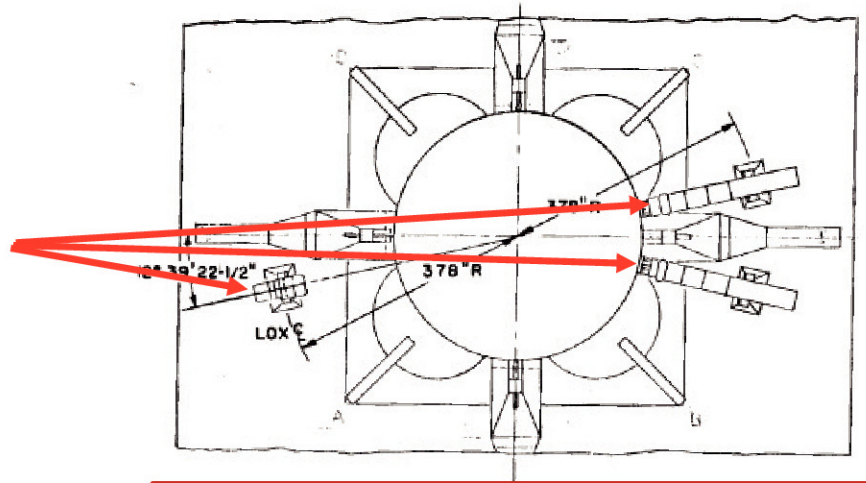

Tower

Place Saturn V on Launcher and use as reference for Masts.

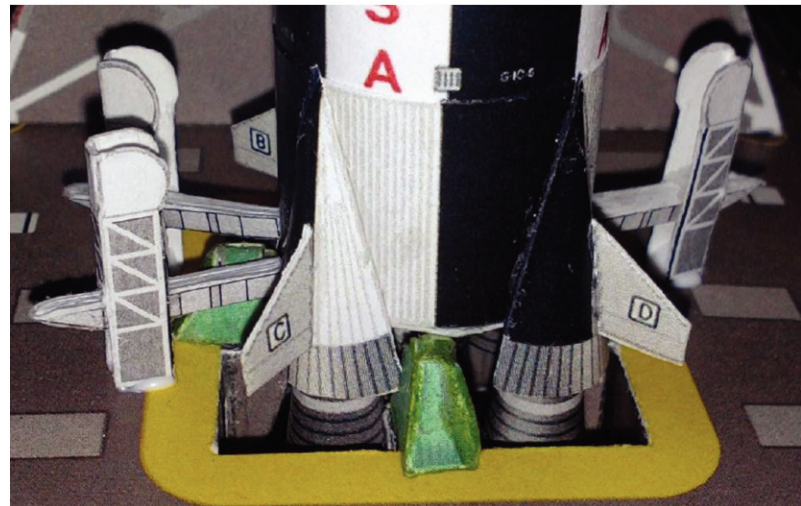

62. Score, cut out, fold, and assemble Tower Access Arms. Note numbers on each arm – they correspond to marked positions on the Tower.

Build the Damper Arm. Either assemble the parts shown or laminate 4 sheets of cardstock and glue the Damper Arm graphic to the cardstock assembly. When this assembly is dry, carefully cut out, as with the Tail Service Mast Arms. Color the non-red portions with a red marker.

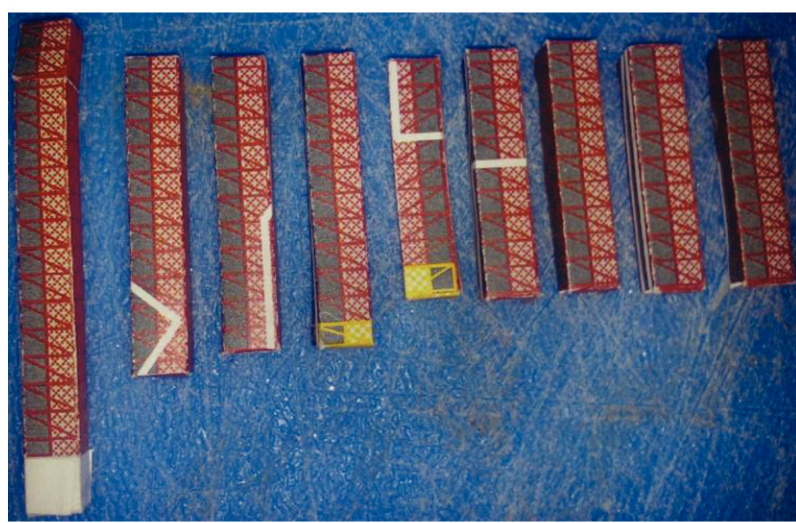

63. Glue Access Arms to the tower, matching the numbered Arm position on the tower to the corresponding arm. Note – Arm position 1 is not marked on the Tower Base. Refer to Appendix for the proper location.

Arms should be canted in, toward the centerline of the Saturn V.

Note: Damper Arm for SA-500F is in a different location than shown in photo. Refer to diagram in Appendix

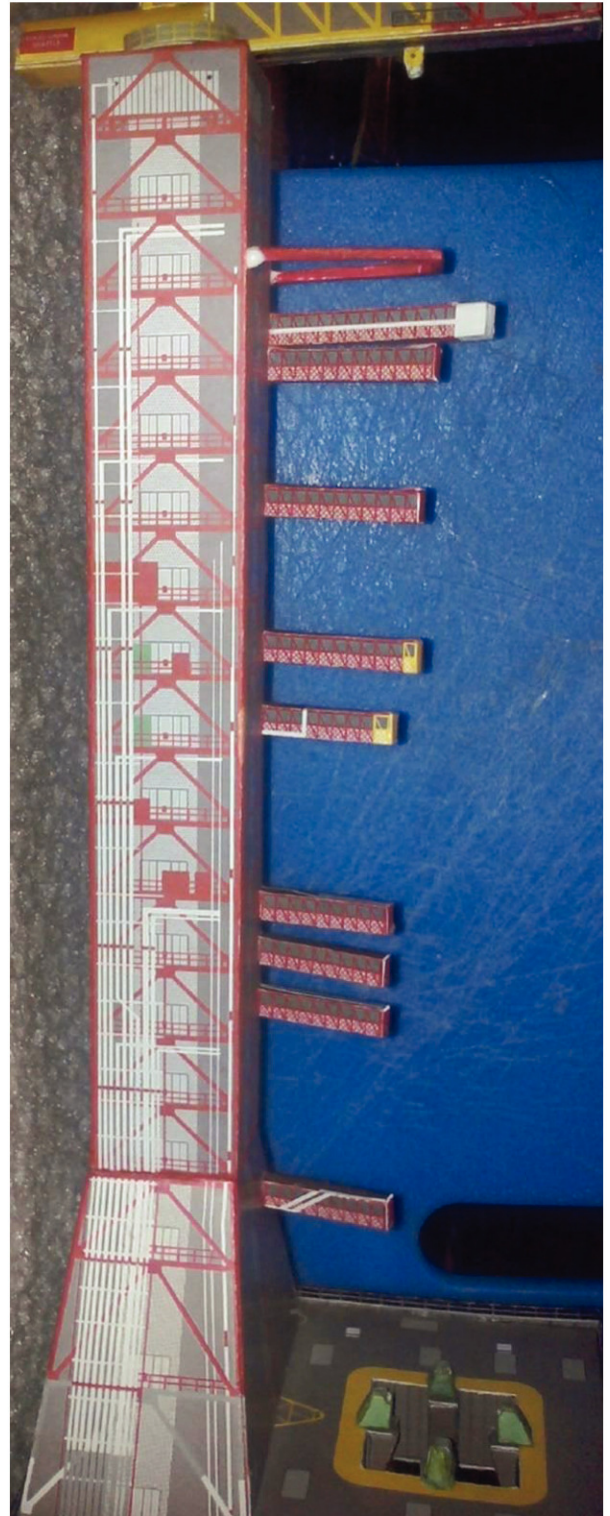

64. If you wish, glue thin wire, stiffened thread, etc to the Damper Arm and the Crew Access arm, to depict the cables attached to these components

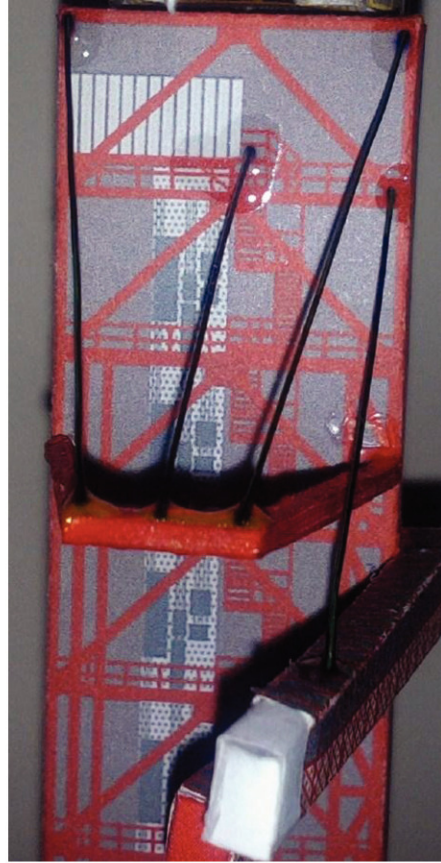

65. Place the Saturn V on the Launcher. Glue if you wish.

Your model is complete.

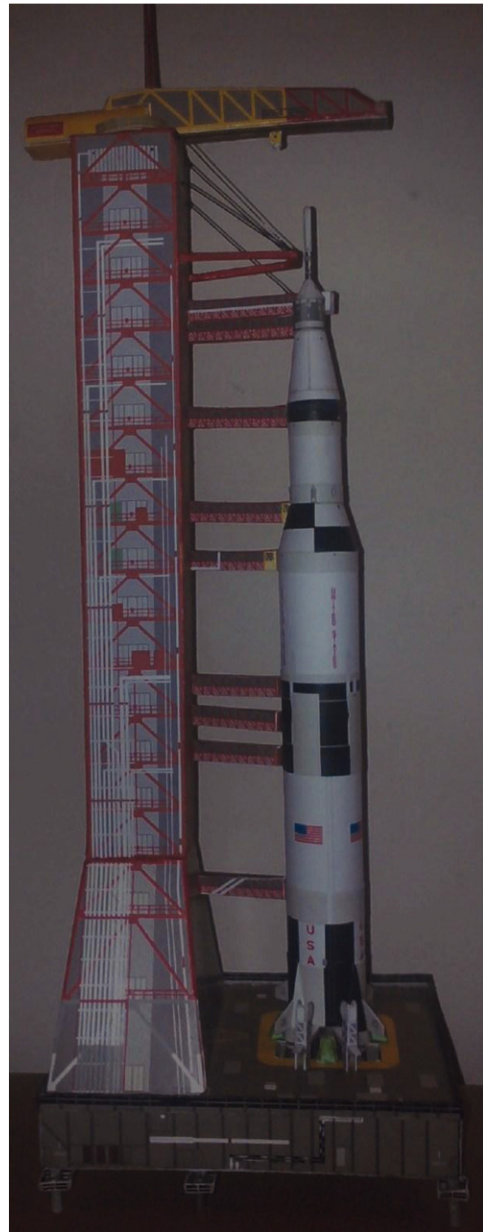

# Skylab Assembly Photos

The following photos depict the assembly of Skylab, using similar techniques as shown for the S-IVB. The S-IC & S-II portions are assembled the same as the Apollo Moon rocket.

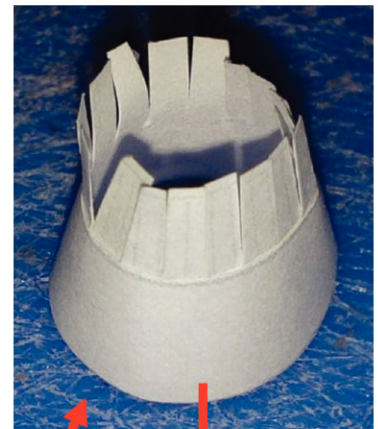
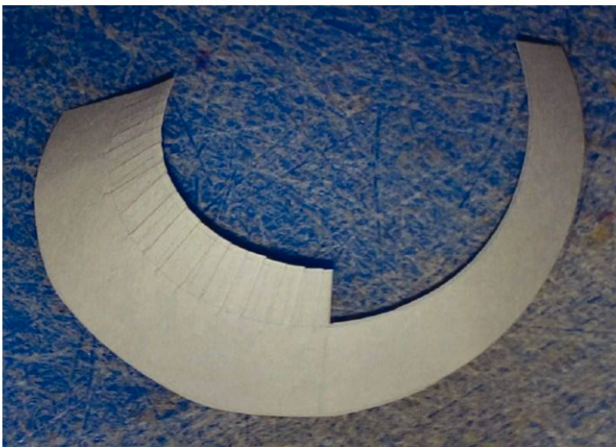

Lower portion of Nosecone. This is a 2-layer part. Fringed portion is the underwrap

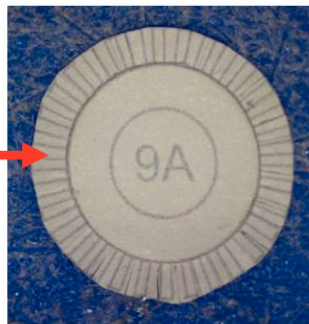
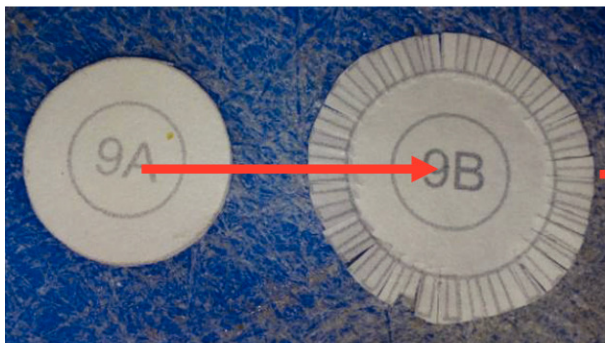

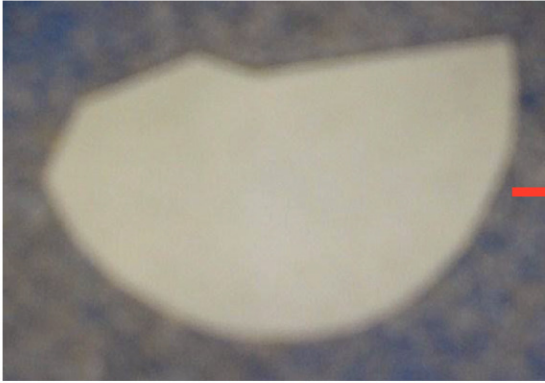

Upper Nose Cone



Roll into cone

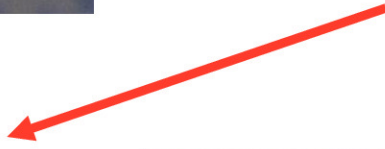
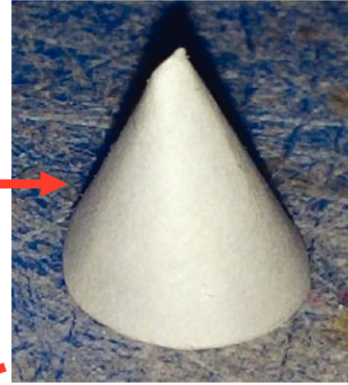

Glue Upper Nose Cone onto lower portion of Nose Cone

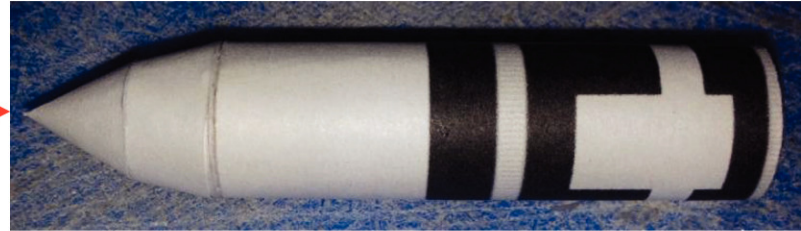

Glue Nosecone onto Orbital Workshop



Glue Skylab onto S-II



# Appendix: Location of Access Arms

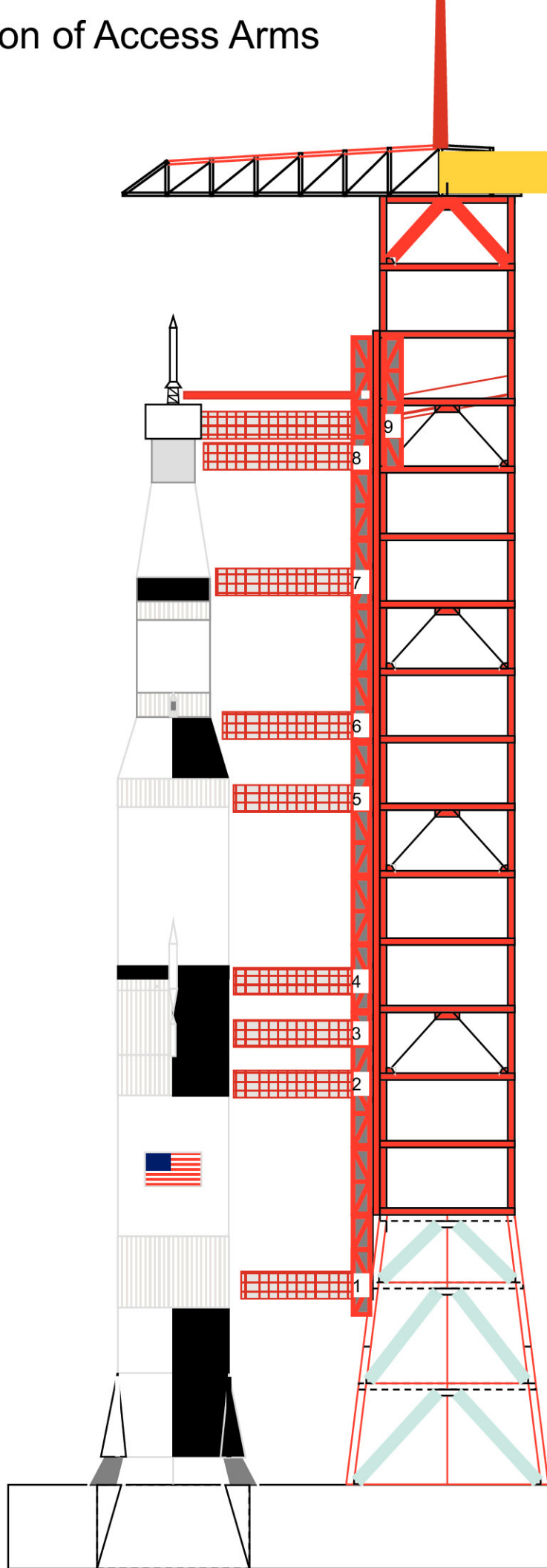

# Appendix: Location of Access Arms for Skylab

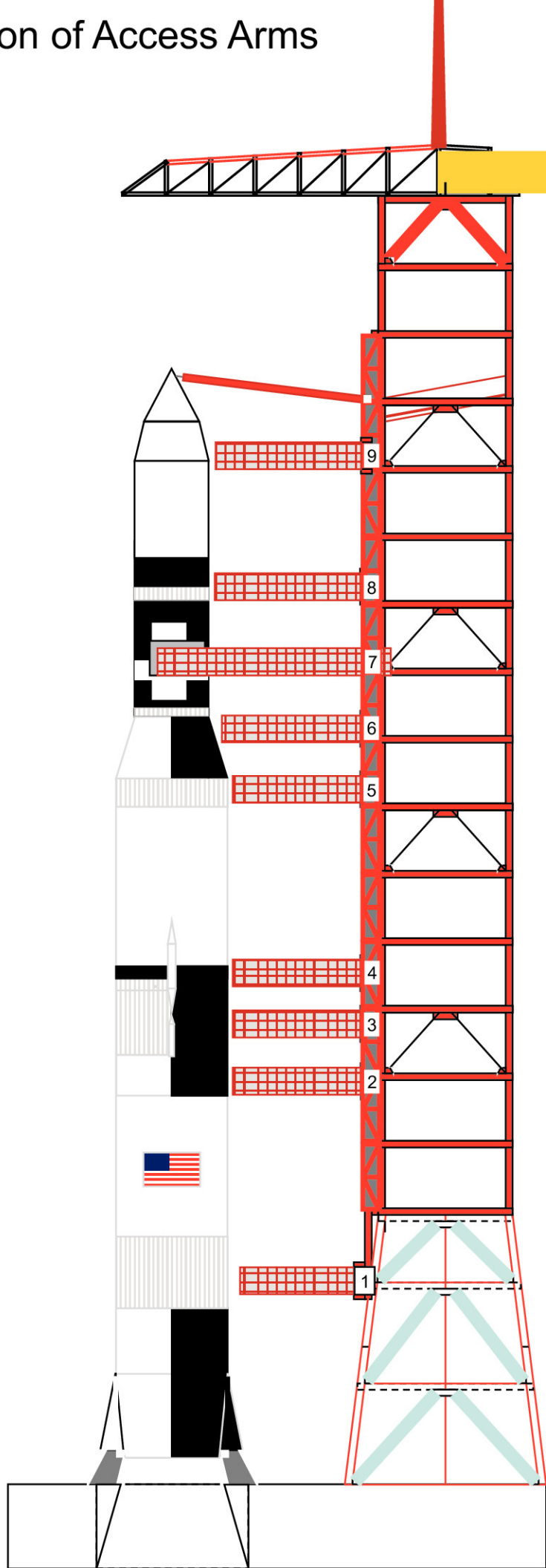

# Appendix: Location of Access Arms for SA-500F

Note Location of Damper Arms

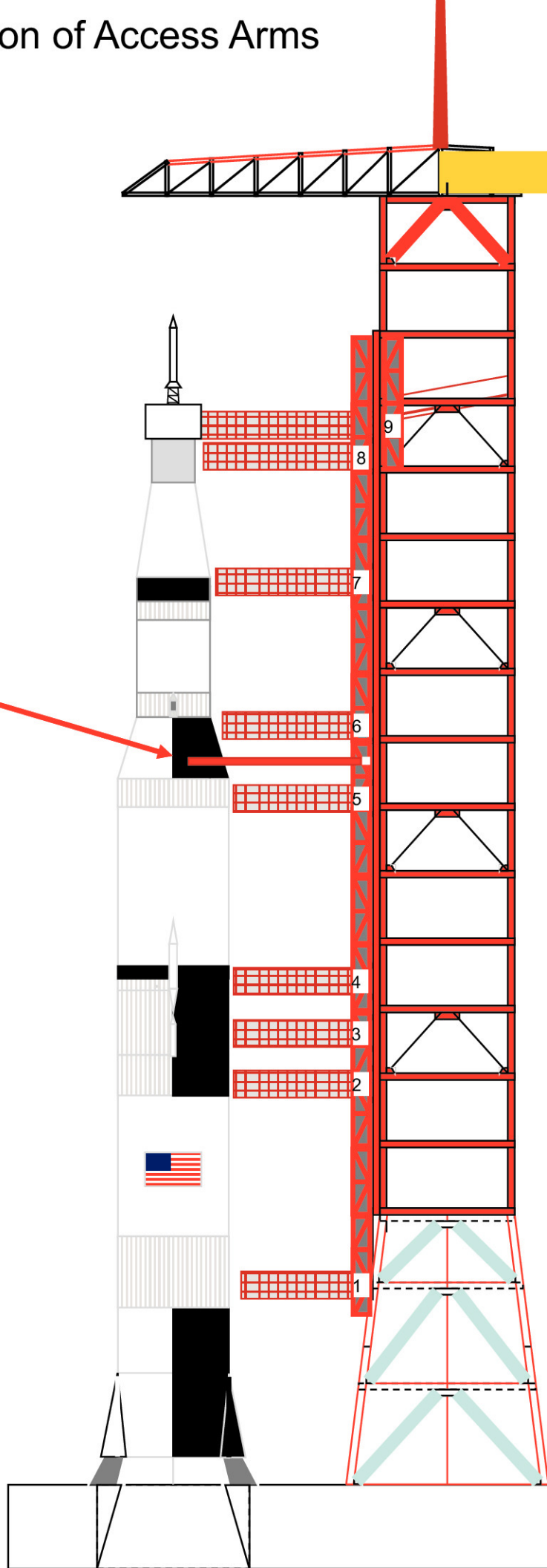

**S-II/Tapered Interstage Adapter**



Cut outer circle into "fringe" gluetabs.

Glue 7B+cardstock to center of 7A.



7C  
Glue to  
Cardstock

**S-IVB/SLA Adapter**

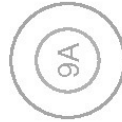

9A  
Glue to  
Cardstock

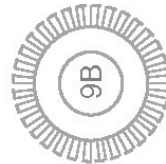

9B

Cut outer circle into "fringe" gluetabs.

Glue 9A+cardstock to center of 9b.

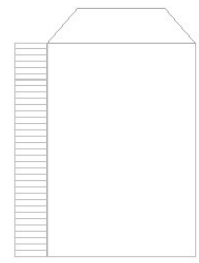

10A -- CM/SM/SLA Connection Tube

**Skylab Nose**

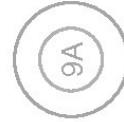
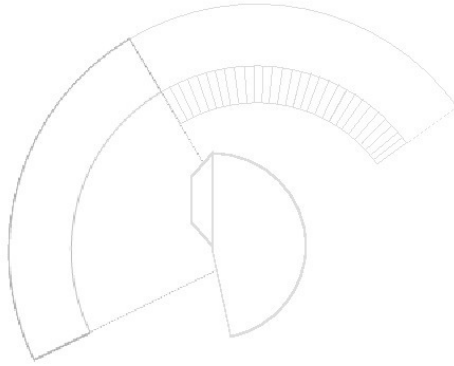

9A  
Glue to  
Cardstock



**Optional Tower Pedestal Legs**

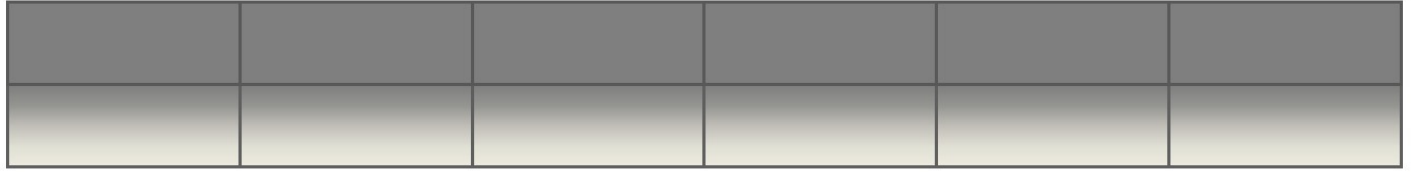

**Tail Service Masts**

**Arms**

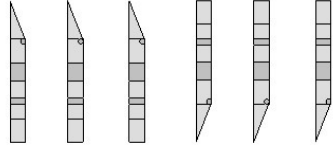

**Towers**

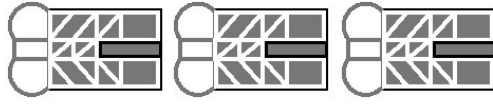

## Service Arms

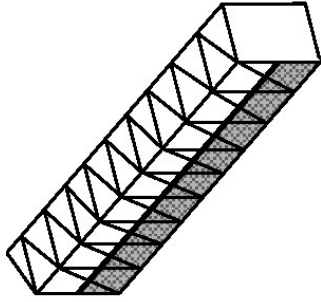

Solid red sections are the walkway (bottom) of the arm – gray section with diagonal cross members are the tops. Sides have diagonal cross members with “mesh” on bottom half.

Both ends are “capped” for rigidity and for mounting to the tower.

All folds are “mountain” folds.

Recommend printing on bond paper.

## SM Arm

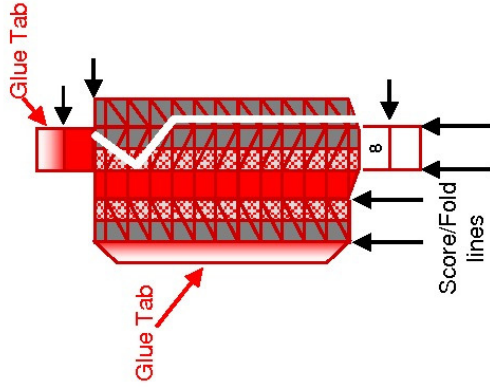

## S-IVB Arms

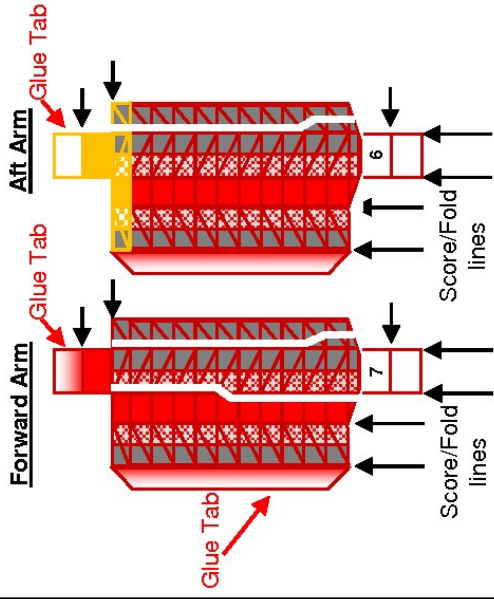

## S-I & S-II Arms

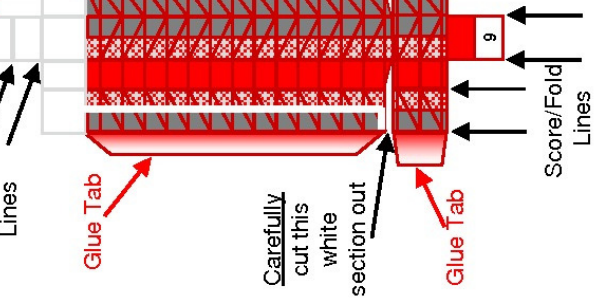
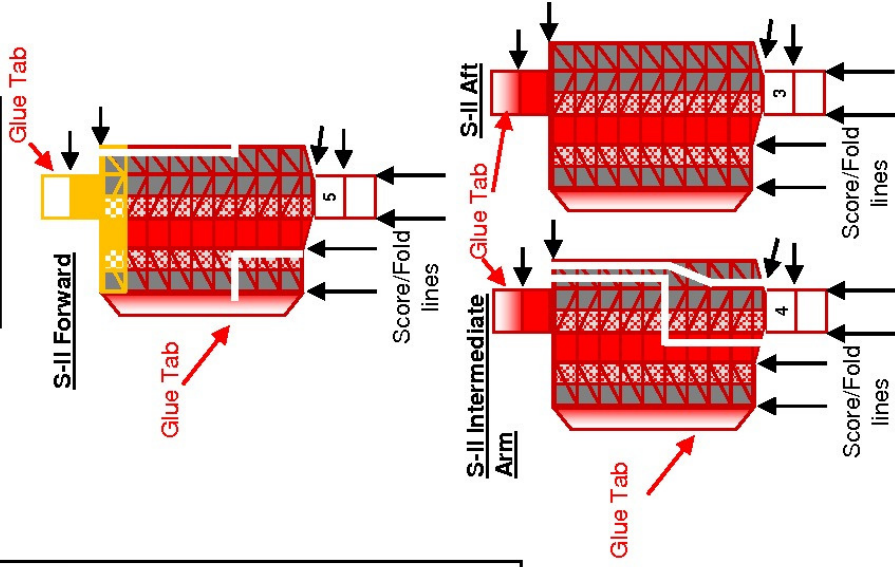

Carefully cut this white section out

Carefully cut this white notch out

When CM Access Arm is complete, from the top, it should be shaped like and mounted to side of tower, like this.

Other arms are mounted to front of tower, like this. (See drawing for placement.)

## CM Access Arm

## PRINT TO BOND PAPER



## Damper Arm

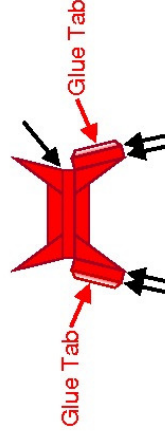
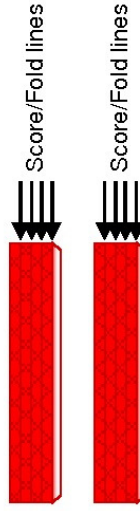

When completed, the Damper arm assembly goes together like this.

Alternately, glue this diagram to three or four laminated pieces of cardstock, cut out, and color in with marker.

Access Arm Girder, Top Section – Side 1

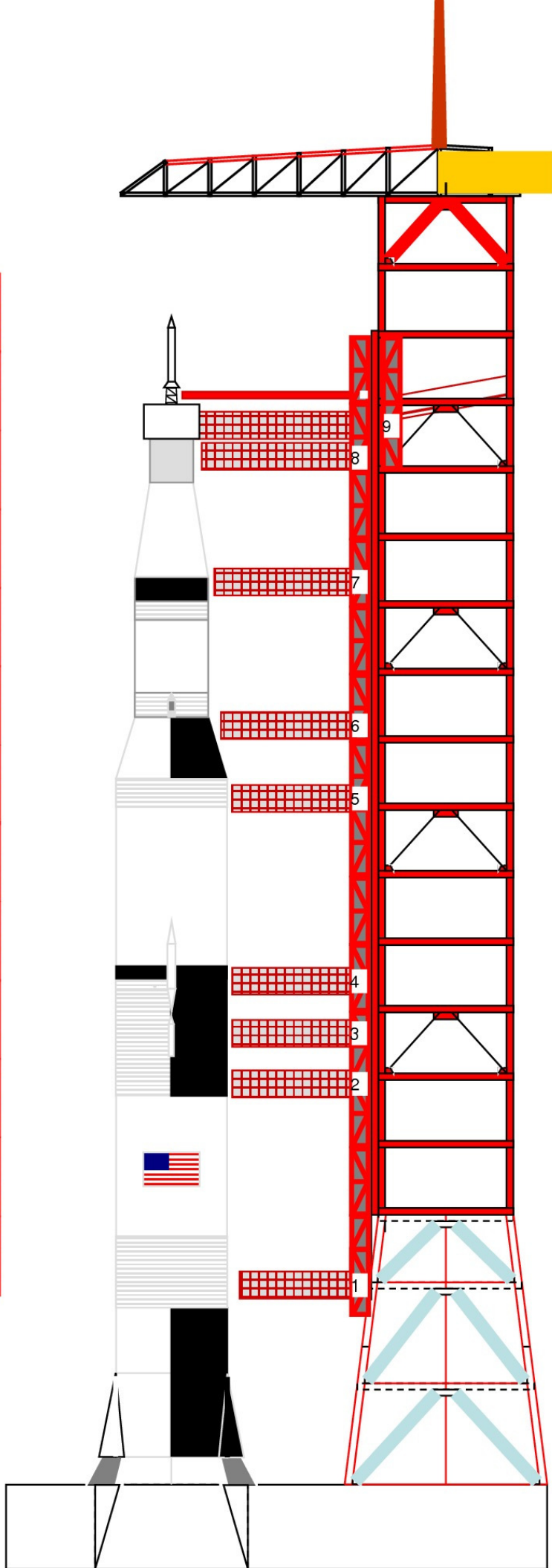

Access Arm Girder,  
Base Section – Side 1



Access Arm Girder, Top Section – Side 4



# Apollo 14 Saturn V SA-509

body wrap

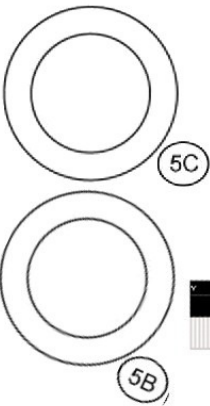

13

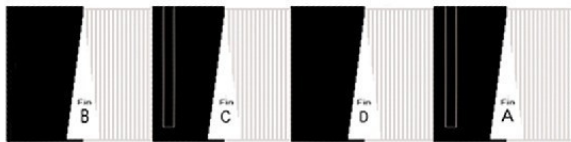

18

body wrap

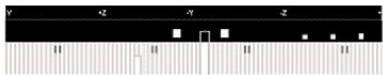

17

body wrap



S-IVB

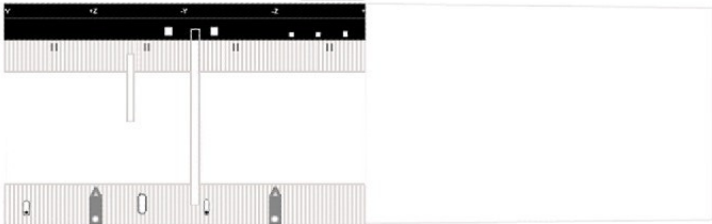

16 body wrap



15 body wrap

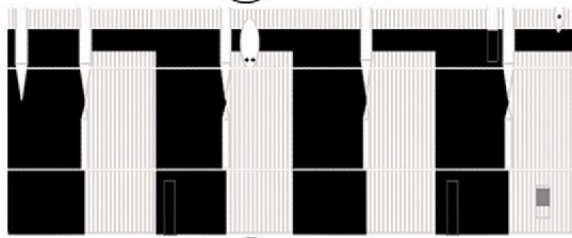

14 body wrap

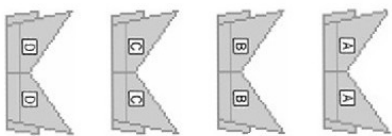
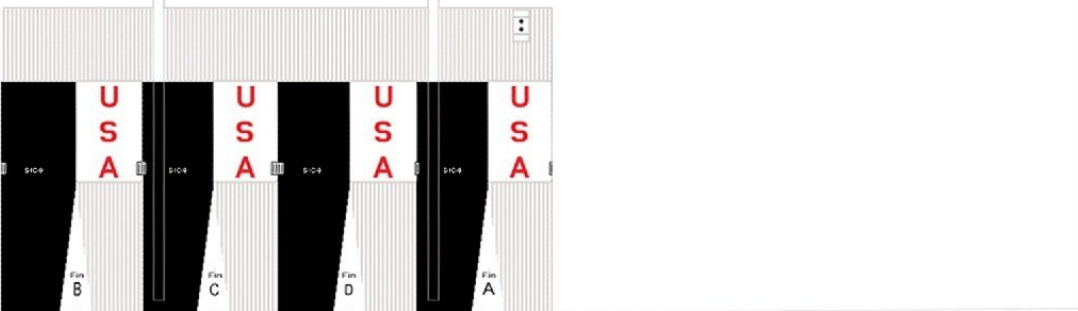
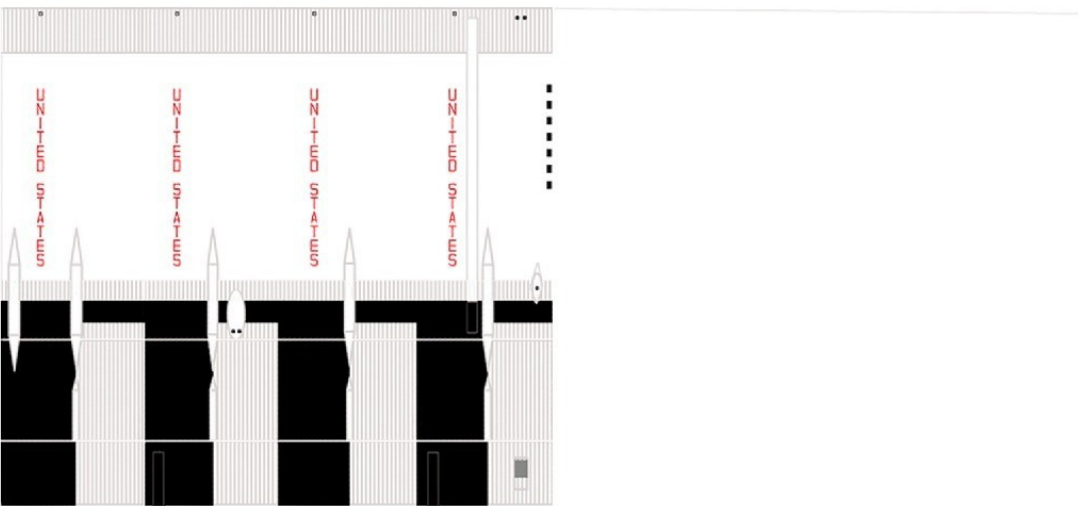

4

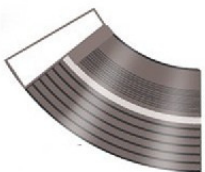

5

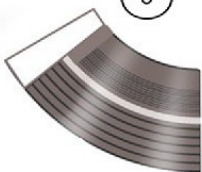

1

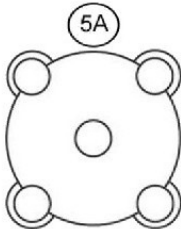

5A

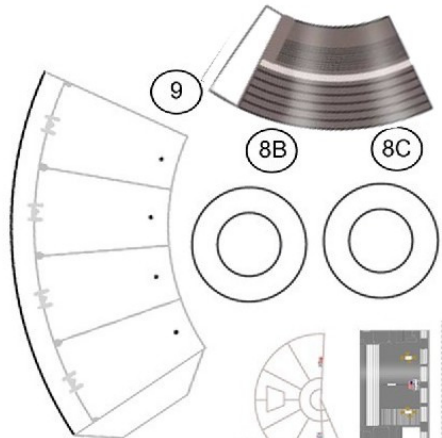

9

8B

8C

11

10

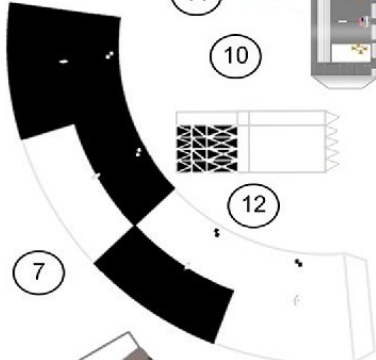

7

12

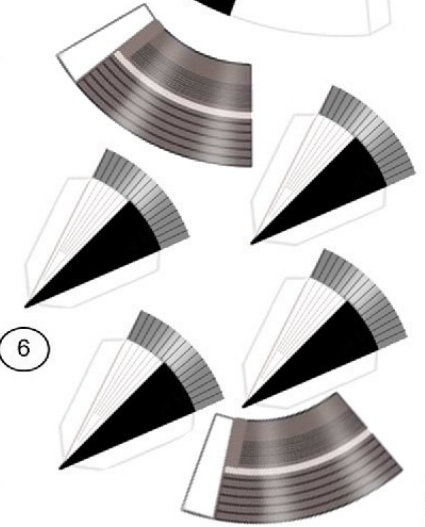

6

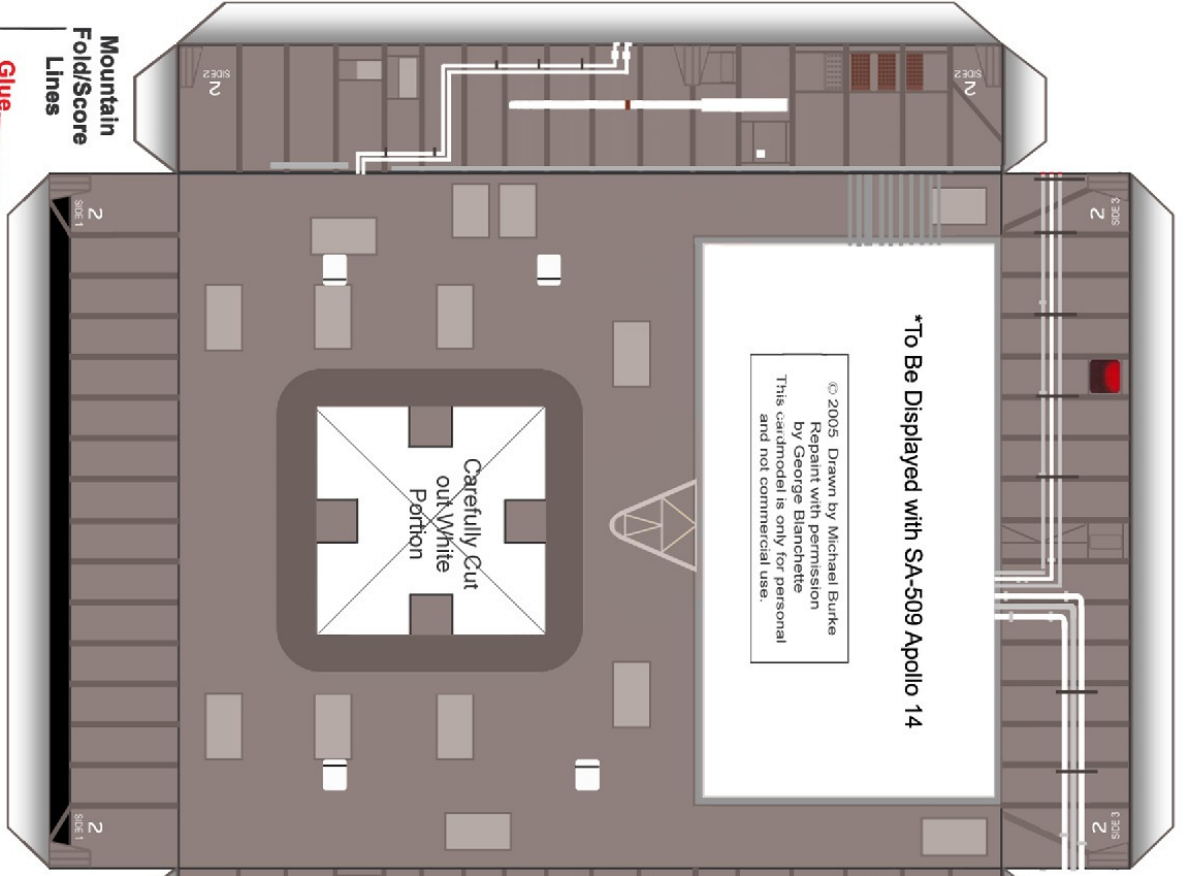

\*To Be Displayed with SA-509 Apollo 14

© 2005 Drawn by Michael Burke  
 Repaint with permission  
 by George Blanchette  
 This cardmodel is only for personal  
 and not commercial use.

Carefully Cut  
 out White  
 Portion

Carefully Cut  
 out White  
 Portion

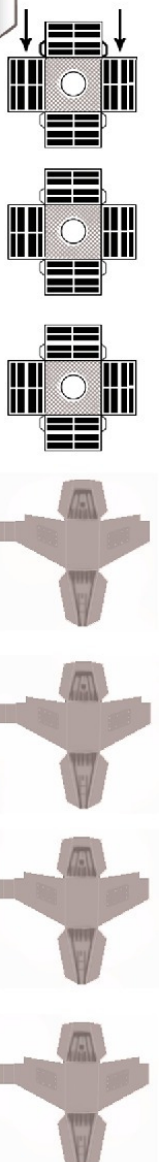

Hold Down Arms

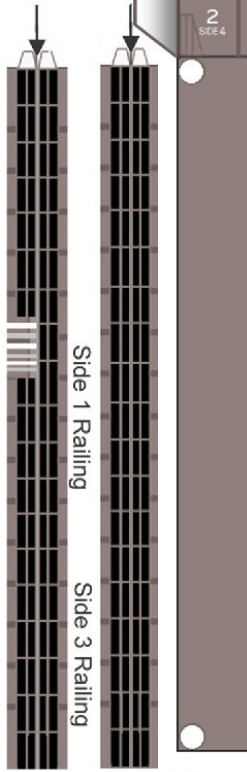
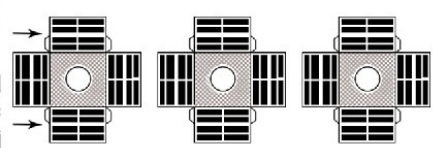
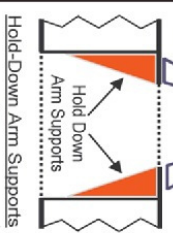

Side 1 Railing

Side 3 Railing

Side 2 Railing

Side 4 Railing

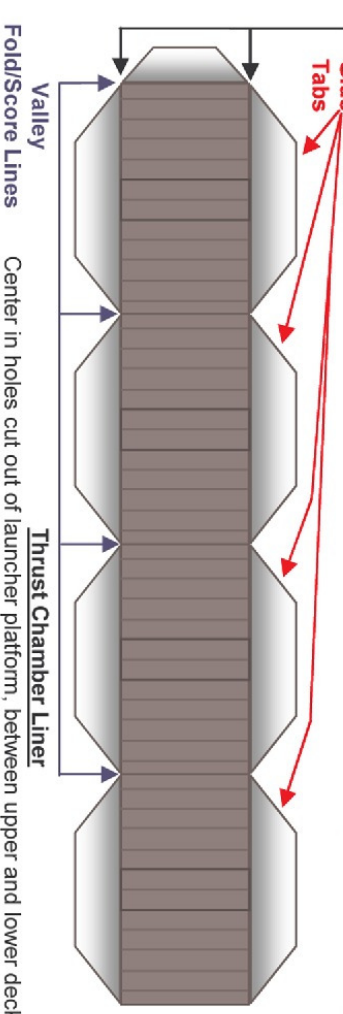

Mountain  
 Fold/Score  
 Lines

Glue  
 Tabs

Valley

Fold/Score Lines

Thrust Chamber Liner

Center in holes cut out of launcher platform, between upper and lower decks.

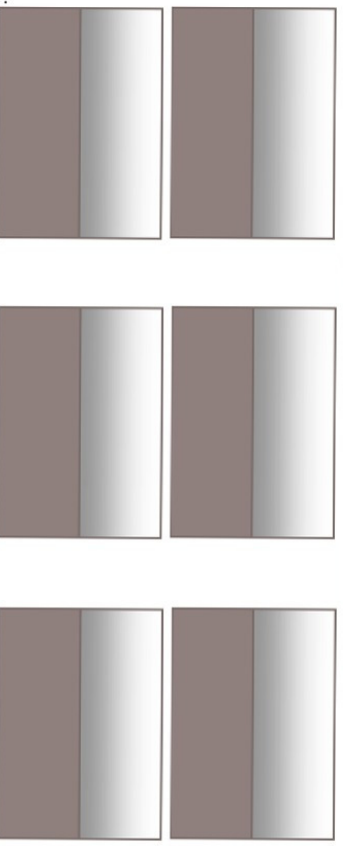

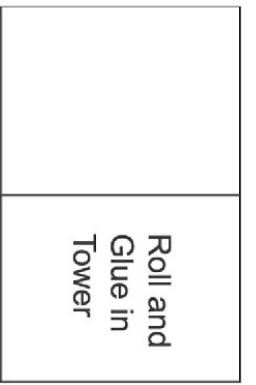

Outer Sleeve

Inner Sleeve

### Lightning Rod

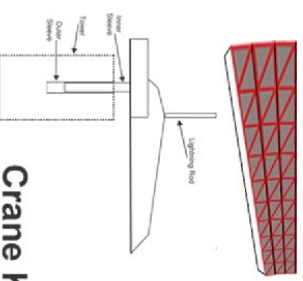

Mountain fold all triangular glue tabs on both ends

Rear

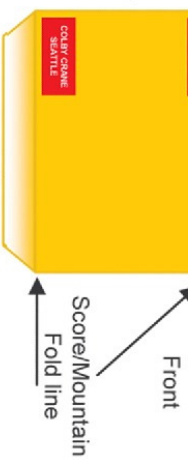

### Machinery House

Mountain Fold/Score lines

### Crane Keel

Sandwich and glue both halves around cardstock

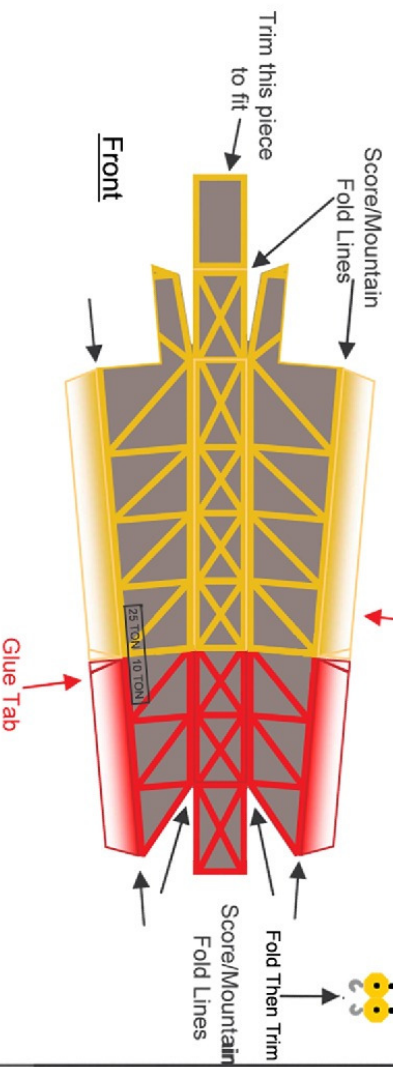
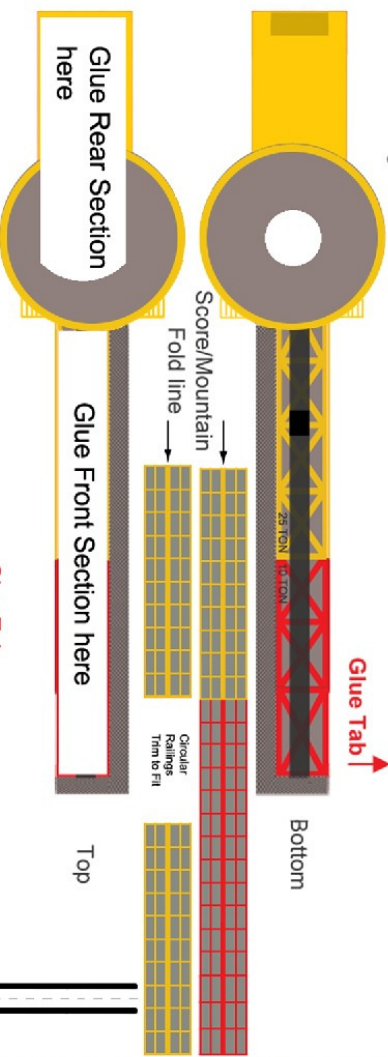

Denote Mountain Fold/Score Lines

### Tower Base

\*To Be Displayed With SA-509 Apollo 14

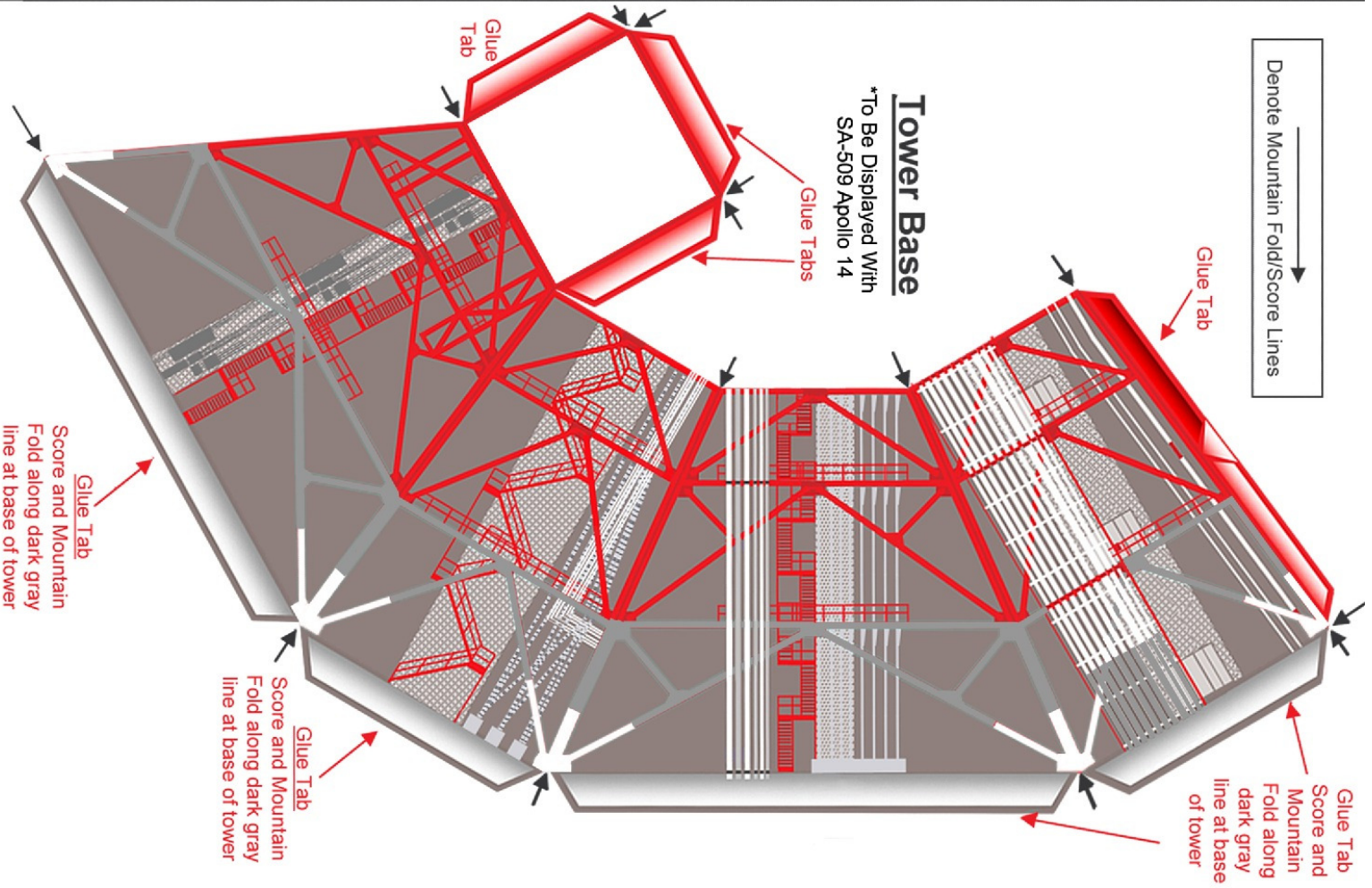

# Launch Umbilical Tower

\* To Be Displayed With SA-509 Apollo 14

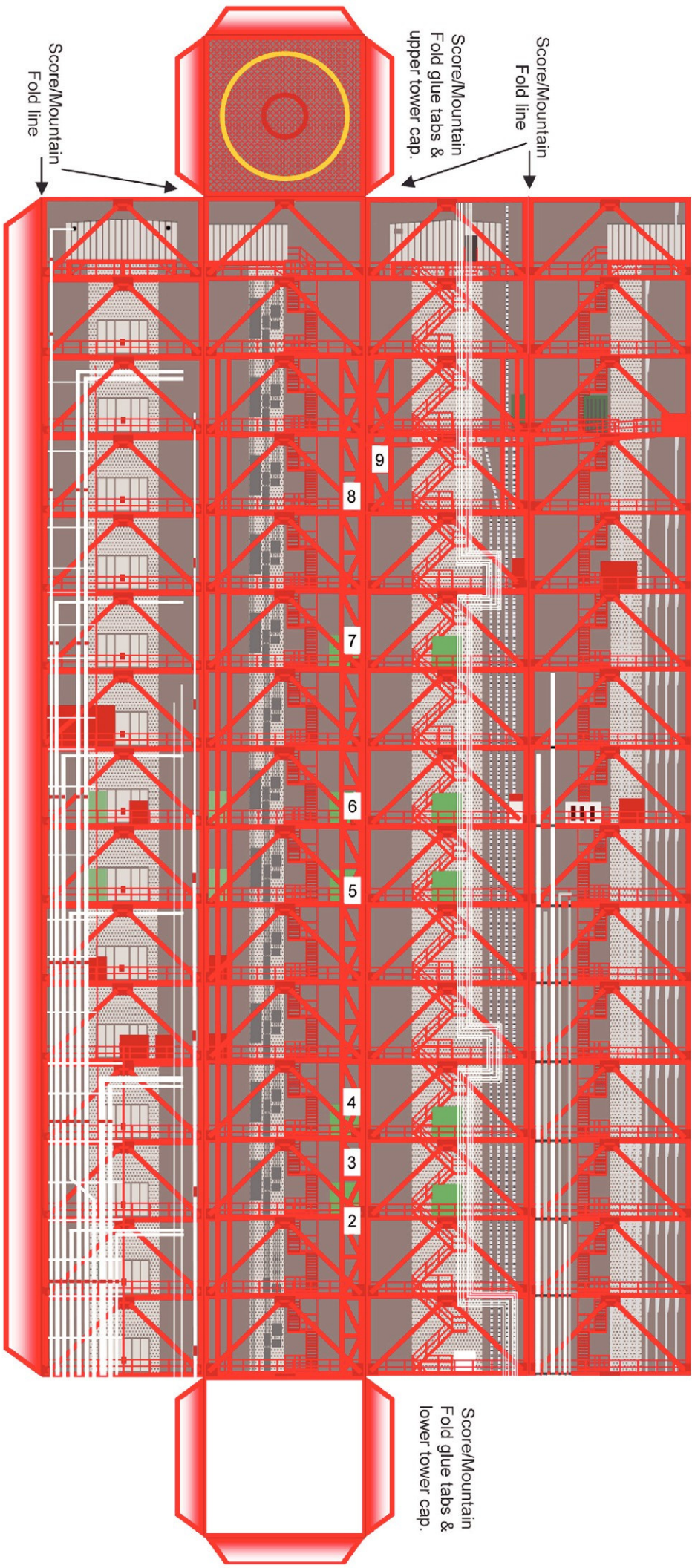

Print on Cardstock

© 2005 Drawn by Michael Burke  
Repaint with permission  
by George Blanchette  
This cardmodel is only for personal  
and not commercial use.